



FILTER WAREHOUSE

www.h2ofilterwarehouse.com

Revised: 4.4.2025



NEW PRODUCTS

**PRO SERIES
CONTROL VALVES**

PAGE
55



**FLECK
COMMERCIAL VALVES**

PAGE
56



**GRANULAR
ACTIVATED
CARBON MEDIA**

PAGE
62



**SOFTENERS WITH
PRO SERIES VALVES**

PAGE
68



**TWIN
SOFTENERS**

PAGE
72



**HARMSCO
STAINLESS STEEL
HOUSINGS**

PAGE
91



HOT PRODUCTS



**CARBON BLOCK
CARTRIDGES**



PAGES 6-11

**PENTEK
FILTER HOUSINGS**



PAGE 51

**MELT BLOWN SEDIMENT
CARTRIDGES**

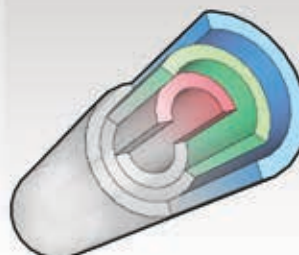

PAGES 26-28

**LUXURY DRINKING
WATER FAUCETS**



PAGES 34-36

TABLE OF CONTENTS

CARTRIDGES

6

CA Ware Carbon Block Cartridges	6
Pentek® Cartridges	8
Omnipure™ Carbon Block Cartridges	10
Aries® Carbon Block Cartridges	11
KX Technologies Carbon Block Cartridges	12
Aries® Filter Works Cartridges	12
Omnipure™ Cartridges & Heads	14
GAC, Carbon/KDF & Empty Refillable Cartridges	17
KemFlo & CA Ware Inline Cartridges	18
Omnipure™ Inline Cartridges	18
Pentek® Inline Cartridges	19
Pentek® Replacement Components	20
Watts® 'Quick Twist' Cartridges	20
Ceramic Cartridges & Candles	20
Hollow Fiber Membrane & Carbon Block Element	21
Everpure Commercial Cartridges	22
Everpure Commercial Systems	23
Residential Reverse Osmosis Membranes	24
Commercial Reverse Osmosis Membranes	25
American Melt Blown Sediment Cartridges	26
Melt Blown Polypropylene Sediment Cartridges	27
Grooved Melt Blown Polypropylene Sediment Cartridges	28
Pentek® Melt Blown & Pleated Sediment Cartridges	28
Shelco® String Wound Sediment Cartridges	29
High Temperature Sediment Cartridges	30
Harmsco® Pleated Sediment Cartridges	31

COMPONENTS

33

Miscellaneous Components	33
Faucets	34
John Guest® Fittings	37
John Guest® Valves	39
John Guest® Tubing	39
John Guest® Tools	40
John Guest® CTS Fittings (¾" & 1" Pipe Sizes)	40
SharkBite® Fittings	42
Organic® Fittings	45
Ball Valves & Tubing	46
Reverse Osmosis Components	46
Installation Accessories	48

Filter Housings	49
Pentek® Filter Housings	51
Pentek® Brackets, Wrenches & O-Rings	52
Filter Housing Wrenches, O-Rings & Brackets	52
Booster, Delivery & Permeate Pumps	53
HM Digital™ Meters & Monitors	54
Pro Series Replacement Control Valves	55
Fleck® Control Valves	56
Structural® Tanks	59
Stenner Pumps	61
Granular Activated Carbon Media	62
pH Correction Medias	63
Iron & Sediment Removal Medias	63
Resins	63
Stainless Steel Connectors	64

SYSTEMS

65

Whole House Carbon Filters	65
Water Softeners	68
Well Water Systems	73
Reverse Osmosis Systems	75
Pentek® Drinking Water Systems	77
Hydrotech® Reverse Osmosis Systems	78
Watts® Kwik-Change System Kits	79
H2O International Sealed Under Sink Filters	80
H2O International Countertop & Icemaker Filters	80
Shower Heads & Filters	81
H2O Filter Warehouse Under Sink Systems	82
Gravity Filters	82
Doulton® Systems	83
Point of Use (POU) Water Cooler Accessories	83
Viqua® Ultraviolet Systems	84
Sterilight® Ultraviolet Systems	86
UV Max™ Ultraviolet Systems	88
Accessories for UV Systems	90
Harmsco® Stainless Steel Filter Housings	91
Shelco® Gasket Seals	96
Big-Bubba® High Flow, Industrial Filter Housing	97

FORMS & TERMS

96

Order Form	98
Terms And Conditions	99

Let Our Warehouse Be Your Warehouse

H2O Filter Warehouse will drop ship orders to your customers. If you have customers that you ship to, we can offer you the opportunity to save on shipping, warehousing and handling costs by letting us stock and ship products to your customers, so you don't have to.



- ◆ Blind shipments with no H2O Filter Warehouse markings on boxes or labels
- ◆ Order confirmations faxed or emailed
- ◆ Shipping confirmations with tracking #'s emailed
- ◆ Same or next day shipping
- ◆ Use your packing list (when you email it to us)
- ◆ Daily pick ups with UPS & FedEx
- ◆ Shipping Terms: Prepay And Add
- ◆ Save the cost of shipping between us and you

Our family of friendly and knowledgeable staff members has over 80 years of experience in water treatment.



Bo Blasingame

Master Water Specialist



Edward Starr

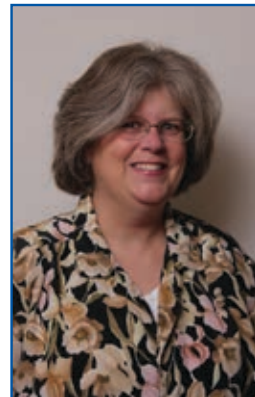

Jennifer Harris



Mark Tibbetts

CWS IV





FILTER WAREHOUSE

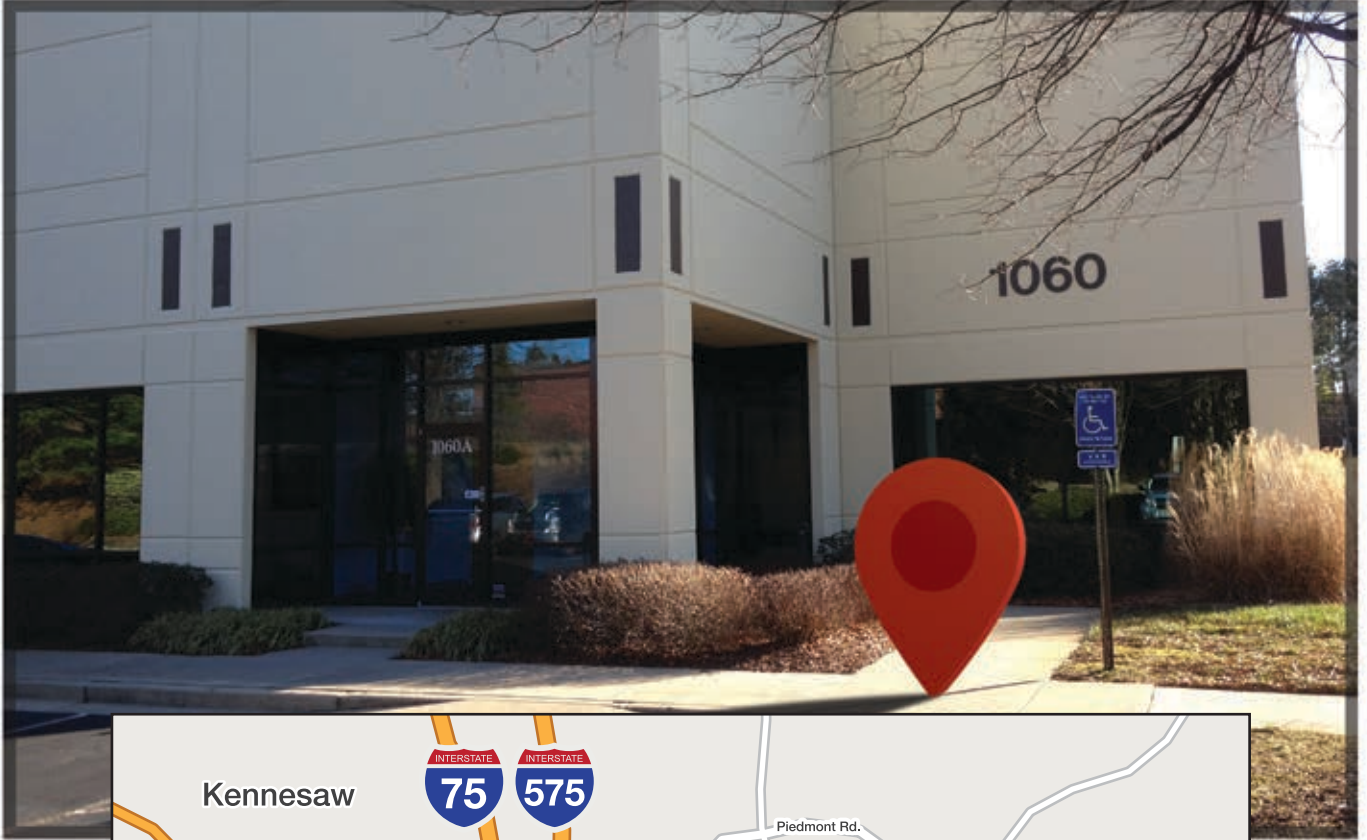



10" x 2½" Coconut Shell Carbon Block Cartridges

Part Number	Former Part Number	Description	Micron	Case Qty	Case Wgt	Your Price
CBC10-10	CBC-10-10	10" x 2½" Carbon Block – NSF Certified	10µ	20	19 lbs.	Call for Pricing
CBC10-10N	CBC-10-10-N	10" x 2½" Carbon Block – No Label	10µ	20	19 lbs.	Call for Pricing
CBC05-10	CBC-10-5	10" x 2½" Carbon Block – NSF Certified	5µ	20	19 lbs.	Call for Pricing
CBC05-10N	CBC-10-5-N	10" x 2½" Carbon Block – No Label	5µ	20	19 lbs.	Call for Pricing
CBC01-10	CBC-10-1	10" x 2½" Carbon Block	1µ	20	19 lbs.	Call for Pricing
KLBG01-10	LBC-10-1	10" x 2½" Carbon Block w/ Lead Removal	1µ	20	18 lbs.	Call for Pricing



20" x 2½" Coconut Shell Carbon Block Cartridges

Part Number	Former Part Number	Description	Micron	Case Qty	Case Wgt	Your Price
CBC10-20	CBC-20-10	20" x 2½" Carbon Block – NSF Certified	10µ	12	24 lbs.	Call for Pricing
CBC05-20	CBC-20-5	20" x 2½" Carbon Block – NSF Certified	5µ	12	24 lbs.	Call for Pricing
CBC05-20N	CBC-20-5-N	20" x 2½" Carbon Block – No Label	5µ	12	24 lbs.	Call for Pricing
CBC01-20	CBC-20-1	20" x 2½" Carbon Block	1µ	12	24 lbs.	Call for Pricing



10" x 4½" Coconut Shell Carbon Block Cartridges

Part Number	Former Part Number	Description	Micron	Case Qty	Case Wgt	Your Price
CBC10-B10	BCBC-10-10	10" x 4½" Carbon Block	10µ	12	33 lbs.	Call for Pricing
CBC05-B10	BCBC-10-5	10" x 4½" Carbon Block – NSF Certified	5µ	12	33 lbs.	Call for Pricing
CBC01-B10	BCBC-10-1	10" x 4½" Carbon Block	1µ	12	33 lbs.	Call for Pricing



20" x 4½" Coconut Shell Carbon Block Cartridges

Part Number	Former Part Number	Description	Micron	Case Qty	Case Wgt	Your Price
CBC10-B20	BCBC-20-10	20" x 4½" Carbon Block	10µ	6	43 lbs.	Call for Pricing
CBC05-B20	BCBC-20-5	20" x 4½" Carbon Block – NSF Certified	5µ	6	43 lbs.	Call for Pricing
CBC01-B20	BCBC-20-1	20" x 4½" Carbon Block	1µ	6	43 lbs.	Call for Pricing
KLBG05-B20	BLBC-20-5	20" x 4½" Carbon Block w/ Lead Removal	5µ	6	43 lbs.	Call for Pricing

- ◆ Coconut Shell Activated Carbon Block
- ◆ Made from 100% Coconut Shell
- ◆ Chlorine, Taste & Odor Removal
- ◆ Lead Removal*
- ◆ Low Pressure Drop
- ◆ NSF 42 Certified for Materials Safety**

*KLB Cartridges use Lead Removal Media and Carbon Block
 **Not all cartridges are NSF Certified





Cawware[®] COCONUT SHELL CARBON BLOCK CARTRIDGES

IN 1, 5 & 10 MICRONS
AVAILABLE IN 5 STANDARD SIZES

TOP QUALITY NSF

Pentek® Cartridges

Pentek® Cartridges shown are stock items. Pentek® ChlorPlus cartridges are not NSF Certified. Pentek® Cartridges you need that are not shown can be drop shipped in case quantities.

Pentek® Standard Carbon Block Cartridges

Part Number	Model	Description	Micron	Capacity (Gallons)	Case Qty	Case Wgt	Your Price
655130-43	DFX-CB-10	9¾" x 2½" 10µ Nominal Rated Carbon Block, High Dirt Holding Capacity, PP Layer	10µ	2,500	12	11 lbs.	Call for Pricing
455903-43	FloPlus-10	9¾" x 2½" Cyst Removal Carbon Block	0.5µ	10,000	12	7 lbs.	Call for Pricing
155162-43	CBC-10	9¾" x 2½" Cyst Removal Carbon Block	0.5µ	20,000	12	14 lbs.	Call for Pricing
155713-43	CCBC-10	9¾" x 2½" Coconut Shell Carbon Block	1µ	20,000	12	14 lbs.	Call for Pricing
155268-43	CBR2-10	9¾" x 2½" Lead & Cyst Carbon Block	0.5µ	20,000	12	19.4 lbs.	Call for Pricing
655208-43	LR-FB10	9¾" x 2½" Lead, Cyst, Taste & Odor Removal	0.5µ	1,500	12	8 lbs.	Call for Pricing
155531-43	EP-10	9¾" x 2½" High Dirt Holding Capacity	5µ	6,000	12	14 lbs.	Call for Pricing
155634-43	EPM-10	9¾" x 2½" High Dirt Holding Capacity	10µ	3,000	12	14 lbs.	Call for Pricing
255382-43	CB1-10	9¾" x 2½" 1µ Nominal Rated Carbon Block	1µ		12	13.2 lbs.	Call for Pricing
455904-43	FloPlus-20	20" x 2½" Cyst Removal Carbon Block	0.5µ	20,000	12	14.5 lbs.	Call for Pricing
155309-43	CBC-20	20" x 2½" Cyst Removal Carbon Block	0.5µ	45,000	12	15 lbs.	Call for Pricing
155529-43	EP-20	20" x 2½" High Dirt Holding Capacity	5µ	12,000	6	17 lbs.	Call for Pricing
155635-43	EPM-20	20" x 2½" High Dirt Holding Capacity	10µ	6,000	6	17 lbs.	Call for Pricing

Pentek® Big Blue® Carbon Block Cartridges

Part Number	Model	Description	Micron	Capacity (Gallons)	Case Qty	Case Wgt	Your Price
455905-43	FloPlus-10BB	9¾" x 4½" Cyst Removal Carbon Block	0.5µ	25,000	12	9 lbs.	Call for Pricing
155170-43	CBC-BB	9¾" x 4½" Cyst Removal Carbon Block	0.5µ	50,000	4	12.5 lbs.	Call for Pricing
155548-43	EP-BB	9¾" x 4½" High Dirt Holding Capacity	5µ	22,000	4	12.5 lbs.	Call for Pricing
155782-43	EPM-BB	9¾" x 4½" High Dirt Holding Capacity	10µ	15,000	4	12.5 lbs.	Call for Pricing
455906-43	FloPlus-20BB	20" x 4½" Cyst Removal Carbon Block	0.5µ	50,000	6	18 lbs.	Call for Pricing
655223-43	FloPlus-Protect-20BB	20" x 4½" PFOA/PFOS Removal Fiberdyn	0.5µ	15,000	6		Call for Pricing
155312-43	CBC-20BB	20" x 4½" Cyst Removal Carbon Block	0.5µ	150,000	4	28 lbs.	Call for Pricing
155583-43	EP-20BB	20" x 4½" High Dirt Holding Capacity	5µ	40,000	4	28 lbs.	Call for Pricing
155783-43	EPM-20BB	20" x 4½" High Dirt Holding Capacity	10µ	30,000	4	28 lbs.	Call for Pricing

Pentek® Standard Taste & Odor Removal Cartridges

Part Number	Model	Description	Micron	Capacity (Gallons)	Case Qty	Case Wgt	Your Price
155002-43	C1	9¾" x 2¾" Activated Carbon-Imp. Cellulose	5µ	2,500	24	11.3 lbs.	Call for Pricing
155022-43	C2	5" x 2¾" Activated Carbon-Imp. Cellulose	5µ	1,250	24	6.5 lbs.	Call for Pricing
155109-43	GAC-10	9¾" x 2½" Granular Activated Carbon	20µ	5,000	12	12.1 lbs.	Call for Pricing
155155-43	CC-10	9¾" x 2½" Granular Activated Carbon	20µ	7,500	12	12.1 lbs.	Call for Pricing
155367-43	NCP-10	9¾" x 2½" Carbon-Impregnated Pleated	10µ	225	24	11 lbs.	Call for Pricing
155597-43	C1-20	20" x 2½" Activated Carbon-Imp. Cellulose	5µ	5,000	14	12 lbs.	Call for Pricing
155111-43	GAC-20	20" x 2½" Granular Activated Carbon	20µ	10,000	6	16.6 lbs.	Call for Pricing
155397-43	NCP-20	20" x 2½" Carbon-Impregnated Pleated	10µ	450	14	11 lbs.	Call for Pricing
155065-43	RFC-20	20" x 2¾" Radial-Flow GAC	70µ	6,000	6	11.4 lbs.	Call for Pricing

Pentek® Big Blue® Taste & Odor Removal Cartridges

Part Number	Model	Description	Micron	Capacity (Gallons)	Case Qty	Case Wgt	Your Price
155153-43	GAC-BB	9¾" x 4½" Granular Activated Carbon	20µ	12,500	8	19.4 lbs.	Call for Pricing
155398-43	NCP-BB	9¾" x 4½" Pleated Carbon-Impreg. Polyester	10µ	500	8	12.9 lbs.	Call for Pricing
155141-43	RFC-BB	9¾" x 4½" Radial-Flow Carbon	25µ	35,000	8	19.3 lbs.	Call for Pricing
155249-43	GAC-20BB	20" x 4½" Granular Activated Carbon	20µ	25,000	4	19 lbs.	Call for Pricing
155382-43	NCP-20BB	20" x 4½" Pleated Carbon-Impreg. Polyester	10µ	1,000	6	21.6 lbs.	Call for Pricing
155247-43	RFC-20BB	20" x 4½" Radial-Flow GAC	25µ	70,000	6	27.1 lbs.	Call for Pricing
155263-43	RFFE-20BB	20" x 4½" Iron Reduction	25µ	26-160K	4	39 lbs.	Call for Pricing

Pentek® Chloramine Reduction Cartridges

Part Number	Model	Description	Micron	Capacity (Gallons)	Case Qty	Case Wgt	Your Price
255416-43	ChlorPlus-10	9¾" x 2½" Cartridge	1µ	50,000	12	11.6 lbs.	Call for Pricing
255417-43	ChlorPlus-20	20" x 2½" Cartridge	1µ	100,000	6	13.7 lbs.	Call for Pricing
355752-43	ChlorPlus-10BB	9¾" x 4½" Cartridge	1µ	250,000	4	10 lbs.	Call for Pricing
355753-43	ChlorPlus-20BB	20" x 4½" Cartridge	1µ	500,000	4	20 lbs.	Call for Pricing

Pentek® ChlorPlus® Series Radial Flow Carbon Block Cartridges



Part Number	O.D. × Length	Chlorine Taste & Odor Reduction Capacity @ Flow	Chloramine Reduction @ Flow	Nominal Micron Rating	Initial ΔP @ Flow
ChlorPlus-10	2½" × 9¾"	>50,000 gal. @ 1.0 GPM	1,000 gal @ 1.0 GPM	1μ	6.0 psid @ 1.0 GPM
ChlorPlus-20	2½" × 20"	>100,000 gal. @ 2.0 GPM	2,000 gal @ 2.0 GPM	1μ	6.0 psid @ 2.0 GPM
ChlorPlus-10BB	4¼" × 9¾"	>250,000 gal. @ 2.0 GPM	3,500 gal @ 2.0 GPM	1μ	6.0 psid @ 2.0 GPM
ChlorPlus-20BB	4¼" × 20"	>500,000 gal. @ 4.0 GPM	7,000 gal @ 4.0 GPM	1μ	6.0 psid @ 4.0 GPM

The ChlorPlus® carbon block cartridges help reduce sediment while providing greater chloramine performance capacities than granular carbon. They also significantly reduce the carbon fines found in many granular canisters. All of these cartridges utilize advanced activated carbon technology which allows superior chloramine and chlorine reduction.

Pentek® EPM Series Carbon Block Cartridges



Part Number	O.D. × Length	Chlorine Taste & Odor Reduction Capacity @ Flow	Nominal Micron Rating	Initial ΔP @ Flow
EPM-10	2½" × 9¾"	>3,000 gal. @ 1.0 GPM	10μ	1.5 psid @ 1.0 GPM
EPM-20	2½" × 20"	>6,000 gal. @ 2.0 GPM	10μ	1.0 psid @ 2.0 GPM
EPM-BB	4¾" × 9¾"	>15,000 gal. @ 2.0 GPM	10μ	5.0 psid @ 2.0 GPM
EPM-20BB	4¾" × 20"	>30,000 gal. @ 4.0 GPM	10μ	4.0 psid @ 4.0 GPM

EPM Series cartridges are manufactured using a patented process that yields a cartridge with a nominal 10 micron filtration rating, high porosity as well as chlorine taste & odor reduction. The high porosity design helps prevent the cartridge from plugging before its adsorption capability is exhausted, maximizing the utilization of the carbon while maintaining low pressure drop.

These cartridges are protected by Endurawrap®, a uniquely formulated polyolefin bilaminate pre-filter, designed to significantly increase the useful life of the cartridge by trapping sediment that typically plugs carbon block cartridges. EPM Series cartridges are manufactured entirely from FDA-compliant materials making them an ideal choice for a wide range of residential, food service, commercial and industrial applications.

Pentek® EP Series Carbon Block Cartridges



Part Number	O.D. × Length	Chlorine Taste & Odor Reduction Capacity @ Flow	Nominal Micron Rating	Initial ΔP @ Flow
EP-10	2½" × 9¾"	>6,000 gal. @ 1.0 GPM	5μ	3.4 psid @ 1.0 GPM
EP-20	2½" × 20"	>12,000 gal. @ 2.0 GPM	5μ	3.4 psid @ 2.0 GPM
EP-BB	4¾" × 9¾"	>22,000 gal. @ 2.0 GPM	5μ	4.3 psid @ 2.0 GPM
EP20-BB	4¾" × 20"	>40,000 gal. @ 4.0 GPM	5μ	5.5 psid @ 5.0 GPM

EP Series carbon briquette cartridges are manufactured using a patented process that yields a cartridge with a nominal 5 micron filtration rating, high dirt-holding capacity. A high porosity design helps prevent the cartridge from plugging before its adsorption capacity is exhausted, maximizing the utilization of the carbon while maintaining low pressure drop.

These cartridges are protected by Endurawrap®, a uniquely formulated polyolefin bilaminate pre-filter, designed to significantly increase the useful life of the cartridge by trapping sediment that typically plugs carbon block cartridges. EP Series cartridges are manufactured entirely from FDA-compliant materials making them an ideal choice for a wide range of residential, food service, commercial and industrial applications.

Pentek® CBC Series Carbon Block Cartridges



Part Number	O.D. × Length	Chlorine Taste & Odor Reduction Capacity @ Flow	Absolute μm Rating	Nominal Micron Rating	Initial ΔP @ Flow
CBC-10	2½" × 9¾"	>20,000 gal. @ 2.0 GPM	1μ	0.5μ	3.7 psid @ 2.0 GPM
CBC-20	2½" × 20"	>45,000 gal. @ 2.0 GPM	1μ	0.5μ	3.0 psid @ 2.0 GPM
CBC-BB	4¼" × 9¾"	>50,000 gal. @ 2.0 GPM	1μ	0.5μ	4.6 psid @ 2.0 GPM
CBC-20BB	4¼" × 20"	>150,000 gal. @ 4.0 GPM	1μ	0.5μ	8.5 psid @ 4.0 GPM

CBC Series cartridges are highly effective at reducing unwanted bad taste and odor, as well as chlorine taste & odor, from potable drinking water. The unique structure of the carbon block enables it to reduce Giardia, Cryptosporidium, Entamoeba, and Toxoplasma cysts and fine sediment particles down to 0.5 microns.*

CBC Series cartridges are manufactured using a patented process and made entirely from FDA-compliant materials. They are an ideal choice for a wide range of residential, food service, commercial and industrial applications. They also make excellent polishing filters or pre-filters in applications requiring fine filtration and high capacity.

Pentek® FloPlus™ Series Carbon Block Cartridges



Part Number	O.D. × Length	Chlorine Taste & Odor Reduction Capacity @ Flow	Absolute μm Rating	Nominal Micron Rating	Initial ΔP @ Flow
FloPlus-10	2½" × 9¾"	>10,000 gal. @ 1.0 GPM	1μ	0.5μ	2.0 psid @ 1.0 GPM
FloPlus-20	2½" × 20"	>20,000 gal. @ 2.0 GPM	1μ	0.5μ	2.0 psid @ 2.0 GPM
FloPlus-10BB	4¼" × 9¾"	>25,000 gal. @ 2.0 GPM	1μ	0.5μ	4.0 psid @ 2.0 GPM
FloPlus-20BB	4¼" × 20"	>50,000 gal. @ 4.0 GPM	1μ	0.5μ	4.0 psid @ 4.0 GPM

FloPlus™ cartridges utilize a revolutionary new technology that significantly enhances the traditional Fibredyne® product, making it possible to obtain cyst reduction in a cartridge that functions like a nominal 10 micron cartridge. This product boasts extremely low pressure drops and high flow rates – comparable to 10 micron (very open) carbon cartridges. Its efficiency is so high that a 0.5 micron rating is possible, which means that cysts and very small particles can be removed to create cleaner, safer water.

This product is ideal for applications where pressure drop and low flow have been chronic problems in the past, as well as whole house water treatment with the addition of cyst reduction. However, it will address the needs of any end user looking for a product that offers high flow, low pressure drop, infrequent cartridge changes and cyst-free water.

* Based on manufacturer's internal testing.





Omnipure™ Carbon Block Cartridges

Features & Benefits:

High Quality Replacement Filter Elements

The OMB-Series of replacement cartridges feature high quality carbon block media is manufactured from raw materials to precise specifications entirely at the Omnipure US manufacturing facility.

With the highest volume in the industry, the OC-Series filter elements are designed to fit most standard 4⁷/₈" , 9³/₄" and 20" cartridge housings. Omnipure utilizes a spring loading device to compress the media, reducing media migration and ensuring that the water passes properly through the media for optimum filtration. Ask your Omnipure representative about custom formulations and alternative finishing options.

Filter elements are available in 10 micron, 5 micron, 1 micron and 1 micron lead reduction formulations. Elements are finished with a single layer of spun-bonded polypropylene netting. Polypropylene end caps with compression gaskets are standard. Quality American made carbon blocks you can trust.



Omnipure™ GAC & Carbon Block Cartridges

Part Number	Description	Capacity (gallons)	Micron	Case Qty	Case Wgt	Stock	Your Price
OCB934ST T-28	9 ³ / ₄ " GAC (20 × 50 Mesh)	5,000	10μ	25	36 lbs.	NS	Call for Pricing
OCB934RO T-28	9 ³ / ₄ " GAC RO (20 × 50 Mesh)	5,000	5μ	25	36 lbs.	S	Call for Pricing
OCB934RO T-33	9 ³ / ₄ " GAC RO (12 × 40 Mesh)	5,000	5μ	25	33 lbs.	S	Call for Pricing
CS934 T-28	9 ³ / ₄ " GAC (20 × 50 Mesh)	3,500	10μ	25	25 lbs.	S	Call for Pricing
CS934 T-33	9 ³ / ₄ " GAC (12 × 40 Mesh)	3,500	10μ	25	25 lbs.	S	Call for Pricing
OC200 T-33	19 ³ / ₄ " × 2 ¹ / ₂ " GAC (12 × 40 Mesh)	7,500	10μ	9	25 lbs.	NS	Call for Pricing
OMB934-1M	9 ³ / ₄ " × 2.87" Carbon Block w/ Cyst Removal	>15,000	1μ	20	20 lbs.	S	Call for Pricing
OMB934-1ML	9 ³ / ₄ " × 2.87" Carbon Block w/ Lead & Cyst Removal	>2,500	1μ	20	20 lbs.	S	Call for Pricing
OMB934-5M	9 ³ / ₄ " × 2.87" Carbon Block	>10,000	5μ	20	20 lbs.	S	Call for Pricing
OMB934-10M	9 ³ / ₄ " × 2.87" Carbon Block	>10,000	10μ	20	20 lbs.	S	Call for Pricing
OMB200-1ML	20" × 2.87" Carbon Block w/ Lead & Cyst Removal	>5,000	1μ	9	20 lbs.	NS	Call for Pricing
OMB200-5M	20" × 2.87" Carbon Block	>20,000	5μ	9	20 lbs.	S	Call for Pricing





ARIES
FILTERWORKS



Features & Benefits:

Contaminant Reduction

Reduces other chemicals and contaminants in addition to common particulates*

Chlorine taste and odor reduction based on NSF/ANSI Standard 42*, Lead and cyst reduction based on NSF/ANSI Standard 53*

Premium Fine Mesh Coconut Shell Carbon Standard

Activated coconut carbon for purest filtration

Low Pressure Drop

Unique flow-through construction offers lower pressure drop than traditional cartridges

Quality Produced and Made in the USA

Cartridges are manufactured in the USA for Aries FilterWorks, a division of ResinTech®. Strict quality control over all aspects of production allows complete traceability of every cartridge.

*Based on Internal Manufacturer's testing



Aries® Coconut Shell Carbon Block Cartridges

Part Number	Dimensions	Capacity (gallons)	Micron	Cartridge Type	Case Qty	Case Wgt	Stock	Your Price
CB-10-6310-TO	10" x 2½"	>8,000 @ 1 GPM	10µ	Taste & Odor	20	20 lbs.	S	Call for Pricing
CB-10-6310-BB-TO	10" x 4½"	>16,000 @ 3 GPM	10µ	Taste & Odor	9	30 lbs.	NS	Call for Pricing
CB-10-6305-TO	10" x 2½"	8,000 @ 1 GPM	5µ	Taste & Odor	20	20 lbs.	S	Call for Pricing
CB-10-6305-BB-TO	10" x 4½"	16,000 @ 2 GPM	5µ	Taste & Odor	9	30 lbs.	S	Call for Pricing



Model Number	Part Number	Description	Micron Rating	Case Qty	Case Wgt	Your Price
32-250-10-MATRIKX	32-250-10-MKX	10" x 2½" CTO Carbon Block – NSF Certified	5µ	20		Call for Pricing



Aries® Filter Works Cartridges

Actual capacities may vary depending on flow rate, water temperature and water chemistry.



Aries® Acid Washed Coconut Shell Cartridges

Part Number	Dimensions	Flow Rate (GPM)		Capacity (gallons)	Case Qty	Case Wgt	Stock	Your Price
		Operating	Maximum					
AF-10-1052	10" x 2½"	0.75	1.0	4,000	12	15 lbs.	S	Call for Pricing
AF-20-1052	20" x 2½"	1.0	2.0	9,000	9	21 lbs.	S	Call for Pricing
AF-10-1046-BB	10" x 4½"	2.0	4.0	13,000	8	20 lbs.	NS	Call for Pricing
AF-20-1046-BB	20" x 4½"	3.0	5.0	30,000	4	21 lbs.	S	Call for Pricing

Aries® Catalytic Carbon Cartridges for Chloramine & Hydrogen Sulfide Removal

Part Number	Dimensions	Flow Rate (GPM)		Capacity (gallons)	Case Qty	Case Wgt	Stock	Your Price
		Operating	Maximum					
AF-10-1053	10" x 2½"	0.75	1.0	2,000	12	18 lbs.	S	Call for Pricing
AF-20-1053	20" x 2½"	1.0	2.0	3,500	9	25 lbs.	S	Call for Pricing
AF-10-1042-BB	10" x 4½"	2.0	4.0	4,375	8	24 lbs.	S	Call for Pricing
AF-20-1042-BB	20" x 4½"	3.0	5.0	8,750	4	25 lbs.	S	Call for Pricing

Aries® KDF55/Coconut Shell GAC Cartridges

Part Number	Dimensions	Amount of KDF	Flow Rate (GPM)		Capacity (gallons)	Case Qty	Case Wgt	Stock	Your Price
			Operating	Maximum					
AF-10-2010	10" x 2½"	0.5 lbs.	1.0	1.5	8,000	12	20 lbs.	S	Call for Pricing
AF-10-2011	10" x 2½"	1.0 lbs.	1.0	1.5	15,000	12	20 lbs.	S	Call for Pricing
AF-20-2012	20" x 2½"	2.0 lbs.	1.0	2.0	22,000	9	38 lbs.	S	Call for Pricing
AF-10-2012-BB	10" x 4½"	2.0 lbs.	2.0	4.0	35,000	8	42 lbs.	S	Call for Pricing
AF-20-2015-BB	20" x 4½"	5.0 lbs.	3.0	5.0	95,000	4	39 lbs.	S	Call for Pricing

Aries® KDF85/GAC Cartridges

Part Number	Dimensions	Amount of KDF	Flow Rate (GPM)		Capacity (gallons)	Case Qty	Case Wgt	Stock	Your Price
			Operating	Maximum					
AF-10-2210	10" x 2½"	0.5 lbs.	1.0	1.5	8,000	12	20 lbs.	S	Call for Pricing
AF-10-2211	10" x 2½"	1.0 lbs.	1.0	1.5	15,000	12	20 lbs.	S	Call for Pricing
AF-20-2212	20" x 2½"	2.0 lbs.	1.0	2.0	22,000	9	38 lbs.	S	Call for Pricing
AF-10-2212-BB	10" x 4½"	2.0 lbs.	2.0	4.0	35,000	8	42 lbs.	S	Call for Pricing
AF-20-2215-BB	20" x 4½"	5.0 lbs.	3.0	5.0	95,000	4	39 lbs.	S	Call for Pricing

Aries® Calcor Cartridges

Part Number	Dimensions	Flow Rate (GPM)	Capacity (gallons)	Case Qty	Case Wgt	Stock	Your Price
AF-20-3232	20" x 2½"	1.0	13,000	9	41 lbs.	NS	Call for Pricing
AF-10-3232-BB	10" x 4½"	1.5	15,000	8	43 lbs.	S	Call for Pricing
AF-20-3232-BB	20" x 4½"	3.0	36,000	4	48 lbs.	S	Call for Pricing

Aries® Calcor/GAC Cartridges

Part Number	Dimensions	Flow Rate (GPM)		Capacity (gallons)	Case Qty	Case Wgt	Stock	Your Price
		Operating	Maximum					
AF-10-4210	10" x 2½"	0.5	1.0	2,500	12	17 lbs.	S	Call for Pricing
AF-20-4210	20" x 2½"	1.0	2.0	4,300	9	27 lbs.	S	Call for Pricing
AF-10-4210-BB	10" x 4½"	1.5	3.0	5,000	8	26 lbs.	S	Call for Pricing
AF-20-4210-BB	20" x 4½"	3.0	5.0	12,000	4	27 lbs.	S	Call for Pricing

Aries® 100% Premium Cation Resin/Softening Cartridge

Part Number	Dimensions	Flow Rate (GPM)	Capacity (gallons)	Case Qty	Case Wgt	Stock	Your Price
AF-20-3003-BB	20" x 4½"	2.0	6,925	4	27 lbs.	S	Call for Pricing





Aries Cartridge Features:

- ◆ ResinTech Premium Resins
- ◆ Double Open Ended Cartridges
- ◆ Oversized Cartridge Cavities
- ◆ Up To 50% More Media
- ◆ Fits All Standard Housings

Aries® Phosphate

Part Number	Dimensions	Amount of Phosphate	Flow Rate (GPM)		Capacity (gallons)	Case Qty	Case Wgt	Stock	Your Price
			Operating	Maximum					
AF-10-3328	10" x 2½"	1.0 lbs.	0.5	1.0	10,000	12	35 lbs.	S	Call for Pricing
AF-10-3300	10" x 2½"	2.5 lbs.			25,000	12	36 lbs.	S (Ltd)	Call for Pricing
AF-20-3321	10" x 2½"	1.5 lbs.		1.0	42,000	12	35 lbs.	S	Call for Pricing
AF-20-3322	20" x 2½"	2.0 lbs.	1.0	2.0	20,000	9	60 lbs.	NS	Call for Pricing
AF-10-3326-BB	10" x 4½"	3.0 lbs.	2.0	5.0	40,000	8	61 lbs.	S	Call for Pricing
AF-10-3300-BB	10" x 4½"	6.88 lbs.		5.0	68,750	8	56 lbs.	S (Ltd)	Call for Pricing
AF-20-3327-BB	20" x 4½"	5.0 lbs.	3.0	5.0	80,000	4	68 lbs.	S	Call for Pricing

Aries® Phosphate/GAC Cartridges

Part Number	Dimensions	Amount of Phosphate	Flow Rate (GPM)		Capacity (gallons)	Case Qty	Case Wgt	Stock	Your Price
			Operating	Maximum					
AF-20-3310	20" x 2½"	1.0 lbs.	1.0	2.0	8,000	9	28 lbs.	S	Call for Pricing
AF-10-3311-BB	10" x 4½"	1.0 lbs.	2.0	4.0	8,000	8	28 lbs.	S (Ltd)	Call for Pricing
AF-10-3312-BB	10" x 4½"	2.0 lbs.	2.0	4.0	16,000	8	28 lbs.	S	Call for Pricing
AF-20-3312-BB	20" x 4½"	2.0 lbs.	3.0	5.0	16,000	4	28 lbs.	S	Call for Pricing
AF-20-3314-BB	20" x 4½"	4.0 lbs.	3.0	5.0	32,000	4	34 lbs.	S	Call for Pricing

Aries® Fluoride Reduction Cartridges

Part Number	Dimensions	Flow Rate (GPM)		Capacity (gallons)	Case Qty	Case Wgt	Stock	Your Price
		Operating	Maximum					
AF-10-3690	10" x 2½"	0.3	0.6	475	12	20 lbs.	S	Call for Pricing
AF-20-3690	20" x 2½"	0.6	1.2	1,100	9	35 lbs.	S	Call for Pricing
AF-10-3690-BB	10" x 4½"	0.9	1.3	1,200	8	30 lbs.	S	Call for Pricing
AF-20-3690-BB	20" x 4½"	1.5	3.0	2,500	4	34 lbs.	S	Call for Pricing

Aries® Arsenic Removal Cartridges

Part Number	Dimensions	Flow Rate (GPM)		Capacity (gallons)	Case Qty	Case Wgt	Stock	Your Price
		Operating	Maximum					
AF-10-3695	10" x 2½"	0.10	0.40	2,000	12	22 lbs.	S	Call for Pricing
AF-20-3695	20" x 2½"	0.22	0.90	4,000	9	34 lbs.	S	Call for Pricing
AF-10-3695-BB	10" x 4½"	0.25	1.00	4,500	8	31 lbs.	S	Call for Pricing
AF-20-3695-BB	20" x 4½"	0.56	2.22	9,000	4	34 lbs.	S	Call for Pricing

Aries® High Purity Mixed DI Resin Cartridges

Part Number	Dimensions	Flow Rate (GPM)		Capacity (gallons)	Case Qty	Case Wgt	Stock	Your Price
		Operating	Maximum					
AF-10-4010	10" x 2½"	0.2	0.3	450	12	21 lbs.	S	Call for Pricing
AF-20-4010	20" x 2½"	0.2	0.6	900	9	32 lbs.	S	Call for Pricing
AF-10-4010-BB	10" x 4½"	0.5	0.8	1,050	8	29 lbs.	S	Call for Pricing
AF-20-4010-BB	20" x 4½"	0.5	1.5	2,350	4	32 lbs.	S	Call for Pricing

Aries® Color Changing DI Cartridges

Part Number	Dimensions	Media	Flow Rate (GPM)		Capacity (gallons)	Case Qty	Case Wgt	Stock	Your Price
			Operating	Maximum					
AF-10-4030	10" x 2½"	Mixed-bed Resin Blue to Amber	0.2	0.3	450	12	21 lbs.	S	Call for Pricing
AF-20-4030	20" x 2½"	Mixed-bed Resin Blue to Amber	0.2	0.3	900	9	32 lbs.	S	Call for Pricing

Aries® Heavy Metals Removal Cartridges

Part Number	Dimensions	Flow Rate (GPM)		Capacity (gallons)	Case Qty	Case Wgt	Stock	Your Price
		Operating	Maximum					
AF-10-4080	10" x 2½"	0.05	0.11	330	12	21 lbs.	S	Call for Pricing
AF-20-4080	20" x 2½"	0.12	0.24	600	9	32 lbs.	NS	Call for Pricing
AF-10-4080-BB	10" x 4½"	0.13	0.27	680	8	29 lbs.	NS	Call for Pricing
AF-20-4080-BB	20" x 4½"	0.30	0.59	1,500	4	23 lbs.	NS	Call for Pricing





Omnipure Q Series



The Q-Series is the ultimate “user friendly” inline filter on the market. Replacement of the spent media bed is completed, in a matter of seconds, by detaching the filter body from a permanent head with a twist of the wrist. The new filter body is just as easily threaded into the head, and the replacement is then complete. The Q-Series is also available with the optional Twist Tap in-head valve system, which automatically turns the supply water off when the body is disconnected from the head. No tools. No drips. No hassles.

The Q-Series is designed to give customers a high quality, economically priced alternative to similar products on the market. Omnipure’s engineering and production expertise enables them to offer both the initial unit and the replacement bodies at a significantly lower price than the competition.



Omnipure™ Q Series GAC Cartridges



Part Number	Same Item As	Description	Capacity (gallons)	Case Qty	Case Wgt	Stock	Your Price
Q5528	Q5536	10" x 2½" GAC (20 x 50 Mesh)	2,000	25	28 lbs.	NS	Call for Pricing
Q5628	Q5636	12" x 2½" GAC (20 x 50 Mesh)	2,500	25	33 lbs.	NS	Call for Pricing
Q5728	Q5736	14" x 2½" GAC (20 x 50 Mesh)	3,000	20	30 lbs.	NS	Call for Pricing
Q5533	Q5540	10" x 2½" GAC (12 x 40 Mesh)	2,000	25	28 lbs.	NS	Call for Pricing
Q5633	Q5640	12" x 2½" GAC (12 x 40 Mesh)	2,500	25	33 lbs.	S	Call for Pricing
Q5733	Q5740	14" x 2½" GAC (12 x 40 Mesh)	3,000	20	30 lbs.	NS	Call for Pricing

Omnipure™ Q Series Sediment Reduction Cartridges



Part Number	Description	Case Qty	Case Wgt	Stock	Your Price
Q5605	12" x 2½" Sediment Reduction	25	18 lbs.	S	Call for Pricing
Q5705	14" x 2½" Sediment Reduction	20	28 lbs.	NS	Call for Pricing

Omnipure™ Q Series Carbon Block Cartridges



Part Number	Description	Micron	Case Qty	Case Wgt	Stock	Your Price
Q5520	10" x 2½" Carbon Block	1µ	25	33 lbs.	NS	Call for Pricing
Q5620	12" x 2½" Carbon Block	1µ	25	30 lbs.	S	Call for Pricing
Q5720	14" x 2½" Carbon Block	1µ	20	28 lbs.	NS	Call for Pricing
Q5621	12" x 2½" Carbon Block	10µ	25	18 lbs.	S	Call for Pricing

Omnipure™ Q Series Scale Inhibitor Cartridges



Part Number	Description	Capacity (gallons)	Case Qty	Case Wgt	Stock	Your Price
Q5486	8" x 2½" Scale Inhibitor (Keurig Replacement)	1,250	25	26 lbs.	S	Call for Pricing
Q5586	10" x 2½" Scale Inhibitor	1,500	25	30 lbs.	NS	Call for Pricing
Q5686	12" x 2½" Scale Inhibitor	2,000	25	38 lbs.	NS	Call for Pricing

Omnipure™ Q Series Heads



Part Number	Description	Stock	Your Price
Q-NVH-BB	Q Series Non-Valve Head w/ ¼" FNPT	S	Call for Pricing
Q-NVH-CC	Q Series Non-Valve Head w/ ⅜" FNPT	NS	Call for Pricing
Q-NVH-JJ	Q Series Non-Valve Head w/ ¼" Quick-Connect	S	Call for Pricing
Q-NVH-KK	Q Series Non-Valve Head w/ ⅜" Quick-Connect	S	Call for Pricing
8000025	Q Series Bracket w/ Screws	S	Call for Pricing
Q-VH-BB	Q Series Valve Head w/ ¼" FNPT	S	Call for Pricing
Q-VH-JJ	Q Series Valve Head w/ ¼" Quick-Connect	S	Call for Pricing
Q-VH-KK	Q Series Valve Head w/ ⅜" Quick-Connect	S	Call for Pricing

Omnipure L Series



Made of highly durable injection-molded polypropylene, the L-Series is constructed from 100% NSF (National Sanitation Foundation) certified materials. Omnipure offers a variety of standard media options including granular activated carbon (GAC) for taste and odor reduction, depth filtration media to address sand, grit and sediment problems that can clog or damage down line equipment and a special blend polyphosphate media designed to control scaling associated with hard water.

The L-Series can also be ordered with the premium OmnipureBlock™ media. This family of carbon blocks utilizes technology that optimizes surface area for better contaminant absorption. Omnipure-Block™ is available in a high capacity ten micron activated carbon version and a water polishing, cysts-reducing one micron version. A carbon/scale inhibitor and carbon/lead reduction version are available for your specific application needs.



Omnipure™ L Series Acid Washed GAC Cartridges

Part Number	Description	Case Qty	Case Wgt	Stock	Your Price
L5533	10" x 2½" Acid Washed GAC (12 x 40 Mesh)	20	24 lbs.	NS	Call for Pricing
L5633	12" x 2½" Acid Washed GAC (12 x 40 Mesh)	20	28 lbs.	S	Call for Pricing
L5733	14" x 2½" Acid Washed GAC (12 x 40 Mesh)	20	29 lbs.	S	Call for Pricing

Omnipure™ L Series Sediment Reduction Cartridges

Part Number	Description	Case Qty	Case Wgt	Stock	Your Price
L5505	10" x 2½" Block Media Sediment Reduction	20	24 lbs.	NS	Call for Pricing
L5605	12" x 2½" Block Media Sediment Reduction	20	28 lbs.	S	Call for Pricing

Omnipure™ L Series Carbon Block Cartridges

Part Number	Description	Micron	Case Qty	Case Wgt	Stock	Your Price
L5620	12" x 2½" Block GAC	1μ	20	28 lbs.	NS	Call for Pricing
L5621	12" x 2½" Block GAC	10μ	20	28 lbs.	NS	Call for Pricing
L5721	14" x 2½" Block GAC	10μ	20	32 lbs.	S	Call for Pricing

Omnipure™ L Series Specialty Block GAC Cartridges

Part Number	Description	Micron	Case Qty	Case Wgt	Stock	Your Price
L5515	10" x 2½", Block GAC w/ Lead Specific Media	1μ	20	28 lbs.	S	Call for Pricing

Omnipure™ L Series Heads

Part Number	Description	Stock	Your Price
L-NVH-JJ	L Series Non-Valve Head w/ ¼" Quick-Connect & Horizontal Ports	NS	Call for Pricing
L-NVH-KK	L Series Non-Valve Head w/ ⅜" Quick-Connect & Horizontal Ports	NS	Call for Pricing
8000054	L Series Bracket w/ Screws	S	Call for Pricing



Omnipure ELF Series



The ELF-Series of filters from Omnipure was designed specifically for the higher volume requirements for the food service industry. In contrast to what the name implies, the new ELF's (Extra-Large Format) capacity of up to 20,000 gallons and flow rates of up to 2.0 gal/minutes, make it ideal for use in restaurants, cafes, coffee shops and vending machines.

The ELF-Series is engineered in a two-piece configuration with a permanent head and a bayonet style replaceable polypropylene body. This configuration helps to reduce cost as simple body replacement is cheaper than replacing the entire filter apparatus. Replacement is fast and easy. The body is quickly detached from the head with the twist of a wrist, no tool required.

Omnipure™ ELF Series Carbon Block Cartridges



Part Number	Description	Case Qty	Case Wgt	Stock	Your Price
ELF-1M-SB	10" x 3½" Block GAC, 15,000 Gal/1 Yr, 1.67 GPM, 1µ	12	23 lbs.	S	Call for Pricing
ELF-1ML-SB	10" x 3½" Block GAC, 3,000 Gal/1 Yr, 1.67 GPM, 1µ	12	23 lbs.	S	Call for Pricing
ELF-1ML	10" x 3½" Block GAC, 3,000 Gal/1 Yr, 1.67 GPM, 1µ	12	23 lbs.	S	Call for Pricing
ELFXL-1M-SB	15" x 3½" Block GAC, 20,000 Gal/1 Yr, 2.0 GPM, 1µ	6	18 lbs.	NS	Call for Pricing
ELFXL-1-ML-SB	15" x 3½" Block GAC, 4,500 Gal/1 Yr, 2.0 GPM, 1µ	6	18 lbs.	NS	Call for Pricing
ELF-10M-SB	10" x 3½" Block GAC, 10,000 Gal/1 Yr, 1.67 GPM, 10µ	12	23 lbs.	NS	Call for Pricing
ELFXL-10M-SB	15" x 3½" Block GAC, 15,000 Gal/1 Yr, 2.0 GPM, 10µ	6	18 lbs.	NS	Call for Pricing

Omnipure™ ELF Series Carbon Block Cartridges with Phosphate



Part Number	Description	Case Qty	Case Wgt	Stock	Your Price
ELF-1ML-P-SB	10" x 3½" Block GAC w/ Scale Inhibitor & Lead Specific Media, 2,500 Gal/6 Mo, 1.67 GPM, 1µ	12	23 lbs.	S	Call for Pricing
ELF-1ML-P	10" x 3½" Block GAC w/ Scale Inhibitor & Lead Specific Media, 2,500 Gal/6 Mo, 1.67 GPM, 1µ	12	23 lbs.	S	Call for Pricing
ELFXL-1ML-P-SB	15" x 3½" Block GAC w/ Scale Inhibitor & Lead Specific Media, 3,000 Gal/6 Mo, 2.0 GPM, 1µ	6	18 lbs.	NS	Call for Pricing
ELF-10M-P-SB	10" x 3½" Block GAC w/ Scale Inhibitor, 10,000 Gal/Scale 6 Mo, 1.67 GPM, 10µ	12	23 lbs.	NS	Call for Pricing
ELFXL-10M-P-SB	15" x 3½" Block GAC w/ Scale Inhibitor & Lead Specific Media, 10,000 Gal/Scale 6 Mo, 2.0 GPM, 10µ	6	18 lbs.	S	Call for Pricing
ELF-1M-P-SB	10" x 3½" Block GAC w/ Scale Inhibitor, 15,000 Gal/6 Mo, 1.67 GPM, 1µ	12	23 lbs.	S	Call for Pricing
ELF-1M-P	10" x 3½" Block GAC w/ Scale Inhibitor, 15,000 Gal/6 Mo, 1.67 GPM, 1µ	12	23 lbs.	S	Call for Pricing
ELF-5M-P-SB	10" x 3½" Block GAC w/ Scale Inhibitor, 10,000 Gal/6 Mo, 1.67 GPM, 5µ	12	23 lbs.	S	Call for Pricing

Omnipure™ ELF Series Sediment Cartridges with Phosphate



Part Number	Description	Case Qty	Case Wgt	Stock	Your Price
ELF5MSED-SB	10" x 3½" PP Sediment, 15,000 Gal, 1.67 GPM, 5µ	12	18 lbs.	NS	Call for Pricing
ELFXL5MSED-SB	15" x 3½" PP Sediment, 10,000 Gal, 2.0 GPM, 5µ	6	13 lbs.	S	Call for Pricing
ELFXL5MSED	15" x 3½" PP Sediment, 10,000 Gal, 2.0 GPM, 5µ	6	13 lbs.	S	Call for Pricing

Omnipure™ E & ELF Series Heads

Part Number	Description	Case Qty	Your Price
E-NVH-CC	E Series Non-Valve Head w/ ¾" FNPT	S	Call for Pricing
E-NVH-KK	E Series Non-Valve Head w/ ¾" Quick-Connect	S	Call for Pricing
8000025	ELF Series Bracket w/ Screws	S	Call for Pricing

Omnipure E Series



The new E-Series was designed for customers that are already using existing permanent heads but would like an alternative to the replacement bodies currently offered.

The main benefit of the E-Series is price to performance value. E-Series filters, with equal or superior filtration capability, are offered at a considerably lower price than comparable replacement bodies on the market.

Omnipure utilizes several media or media combinations to address standard water problems including granular activated carbon (GAC), polypropylene depth filtration, and polyphosphate. Omnipure also offers one or ten micron carbon blocks, carbon blocks with lead sorbent material and carbon blocks with scale inhibitors to address specific water conditions.

Omnipure™ E Series Cartridges (Everpure Replacements)



Part Number	Description	Case Qty	Case Wgt	Stock	Your Price
E5733	14" x 2½" Acid Washed GAC (12 x 40 Mesh)	12	30 lbs.	NS	Call for Pricing
E5705	14" x 2½" Block Media Sediment Reduction	12	18 lbs.	NS	Call for Pricing

Any Omnipure product not listed can be ordered for you. Call our friendly staff for assistance.

GAC, Carbon/KDF & Empty Refillable Cartridges

Part Number	Description	Case Qty	Case Wgt	Your Price
GAC-10-W	10" x 2½" Coconut Shell GAC Cartridge	25	27 lbs.	Call for Pricing
KDF/GAC	10" x 2½" Coconut Shell GAC Cartridge with KDF	25	38 lbs.	Call for Pricing
KDF/GAC PLUS	Coconut Shell GAC Cartridge with KDF, Replaceable Sediment Pre-filter & Spacer	24	38 lbs.	Call for Pricing
ERC-10-W	10" x 2½" Empty Cartridge w/ PP pads – White	50	15 lbs.	Call for Pricing
ERC-10-C	10" x 2½" Empty Cartridge w/ PP pads – Clear	50	15 lbs.	Call for Pricing



AICRO-NSF



T33-RO



K5633-C-Q

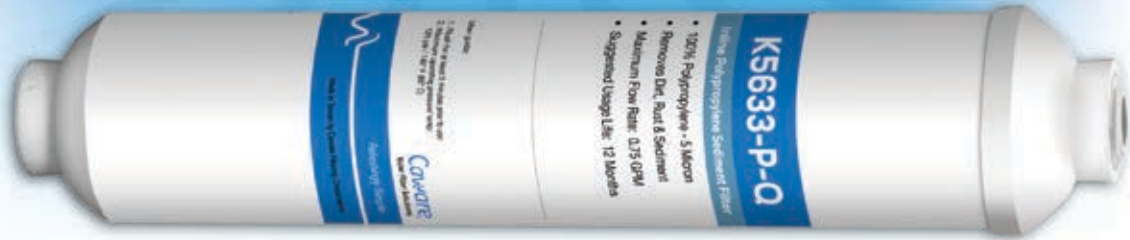

KemFlo & CA Ware Inline Cartridges

Inline Granular Activated Carbon Filters*

Part Number	Description	Case Qty	Case Wgt	Your Price
AICRO-NSF	Kemflo 10" x 2" GAC Inline Filter – NSF Certified – 1/4" FPT	25	16 lbs.	Call for Pricing
AICRO-N	Kemflo 10" x 2" GAC Inline Filter – 1/4" FPT – NO LABEL	25	16 lbs.	Call for Pricing
T33	CA Ware 10" x 2" GAC Inline Filter – 1/4" FPT	25	15 lbs.	Call for Pricing
T33-RO	Same as T33 but w/ RO System Labeling	25	15 lbs.	Call for Pricing
AICRO-Q	Kemflo 10" x 2" GAC Inline Filter – w/ 1/4" Quick-Connect built-in	25	16 lbs.	Call for Pricing
K5633-C-Q	CA Ware 10" x 2" GAC Inline Filter – w/ 1/4" Quick-Connect built-in	25	16 lbs.	Call for Pricing
K5633-C-Q-11	H2O Filter Warehouse 11" x 2 1/2" GAC Inline Filter – w/ 1/4" Quick-Connect built-in	25	26.5 lbs.	Call for Pricing

*All GAC Inlines use coconut shell carbon. See Page 47 for Mounting Clips.

Inline Sediment Filters

Part Number	Description	Case Qty	Case Wgt	Your Price
K5633-P-Q	CA Ware 10" x 2" PP Inline Sediment Filter – w/ 1/4" Quick-Connect built-in, 5µ	25	12 lbs.	Call for Pricing
K5633-P-Q-11	H2O Filter Warehouse 11" x 2 1/2" PP Inline Sediment Filter – w/ 1/4" Quick-Connect built-in, 5µ	25	19 lbs.	Call for Pricing



Omnipure™ Inline Cartridges

BB = 1/4 FNPT, CC = 3/8" FNPT, JJ = 1/4" Quick-Connect & KK = 3/8" Quick-Connect

Omnipure™ CL Series Cartridges



Part Number	Same Item As	Description	Case Qty	Case Wgt	Stock	Your Price
CL6PF5-BB	N/A	6" x 2" PP Sediment Filter, 5µ, 1/4" FNPT	50	8 lbs.	NS	Call for Pricing
CL10PF5-BB	N/A	10" x 2" PP Sediment Filter, 5µ, 1/4" FNPT	25	13 lbs.	NS	Call for Pricing
CL6RO-T33-BB	CL6RO-T40-BB	6" x 2" Taste & Odor Reduction, 1000 Gal, 5µ, 1/4" FNPT	50	11 lbs.	S	Call for Pricing
CL10RO-T33-BB	CL10RO-T40-BB	10" x 2" Taste & Odor Reduction, 1500 Gal, 5µ, 1/4" FNPT	25	19 lbs.	S	Call for Pricing
SCL10-BB	N/A	10" x 2" Taste & Odor Reduction w/ Scale Protection, 1250 Gal, 10µ, 1/4" FNPT	25	21 lbs.	NS	Call for Pricing

Omnipure™ K Series Cartridges



Part Number	Same Item As	Size	Media	Mesh	Capacity	Port	Case Qty	Case Wgt	Stock	Your Price
K2505-JJ	N/A	10" x 2"	Poplypropylene			¼" QC	25	20 lbs.	S	Call for Pricing
K2328-JJ	K2336-JJ	6" x 2"	GAC	20 x 50	1,000 Gal	¼" QC	50	22 lbs.	NS	Call for Pricing
K2528-JJ	K2536-JJ	10" x 2"	GAC	20 x 50	1,500 Gal	¼" QC	25	20 lbs.	S	Call for Pricing
K2528-KK	K2536-KK	10" x 2"	GAC	20 x 50	1,500 Gal	¾" QC	25	20 lbs.	NS	Call for Pricing
K2528-BB	K2536-BB	10" x 2"	GAC	20 x 50	1,500 Gal	¼" FNPT	25	20 lbs.	S	Call for Pricing
K2333-BB	K2340-BB	6" x 2"	GAC	12 x 40	1,000 Gal	¼" FNPT	50	22 lbs.	NS	Call for Pricing
K2333-JJ	K2340-JJ	6" x 2"	GAC	12 x 40	1,000 Gal	¼" QC	50	22 lbs.	NS	Call for Pricing
K2533-JJ	K2540-JJ	10" x 2"	GAC	12 x 40	1,500 Gal	¼" QC	25	19 lbs.	S	Call for Pricing
K2536-JJ	N/A	10" x 2"	GAC	12 x 40	1,500 Gal	¼" QC	25	19 lbs.	S	Call for Pricing
K2540-JJ	K2533-JJ	10" x 2"	GAC	12 x 40	1,500 Gal	¼" QC	25	19 lbs.	S	Call for Pricing
K2533-KK	K2540-KK	10" x 2"	GAC	12 x 40	1,500 Gal	¾" QC	25	19 lbs.	S	Call for Pricing
K2548-JJ	N/A	10" x 2"	Calcite		6 Months	¼" QC	25		S	Call for Pricing
K2551-BB	N/A	10" x 2"	GAC/Calcite			¼" FNPT	25		NS	Call for Pricing
K2551-JJ	N/A	10" x 2"	Calcite/Corosex			¼" QC	25		S	Call for Pricing
K2567-JJ	N/A	10" x 2"	GAC/KDF	20 x 50	1,500 Gal	¼" QC	25	30 lbs.	NS	Call for Pricing



Any Omnipure product not listed can be ordered for you. Call our friendly staff for assistance.



Pentek® Inline Cartridges

Pentek® Coconut Shell Granular Activated Carbon Inline Cartridges



Part Number	Model Number	Dimensions	Port Size	Micron	Case Qty	Case Wgt	Stock	Your Price
255521-43	GS-10RO-B	10" x 2"	¼" FPT	5μ	12	5.7	S	Call for Pricing
255522-43	GS-10RO-C	10" x 2"	¾" FPT	5μ	12	5.7	S	Call for Pricing
255525-43	GS-10RO-G	10" x 2"	¼" John Guest	5μ	12	5.7	S	Call for Pricing
255526-43	GS-10RO-H	10" x 2"	¾" John Guest	5μ	12	5.7	S	Call for Pricing

Pentek® Bacteriostatic Inline Cartridges (KDF & Coconut Shell Carbon)



Part Number	Model Number	Dimensions	Port Size	Micron	Case Qty	Case Wgt	Stock	Your Price
255553-43	GS-10EXTRA.5-B	10" x 2"	¼" FPT	5μ	12	7.2	S	Call for Pricing

Pentek® Lime, Scale, and Chlorine Taste & Odor Inline Cartridge (Hexametaphosphate & Coconut Shell Carbon)



Part Number	Model Number	Dimensions	Port Size	Micron	Case Qty	Case Wgt	Stock	Your Price
255595-43	GS-10ALS-B	10" x 2"	¼" FPT	20μ	12	4.8	S	Call for Pricing

Pentek® Inline Carbon Block Cartridges



Part Number	Model Number	Dimensions	Port Size	Micron	Case Qty	Case Wgt	Stock	Your Price
255631-43	GS-10CB-5-B	10" x 2"	¼" FPT	5μ	12	4.3	S	Call for Pricing
255636-43	GS-10CB-5-H	10" x 2"	¾" John Guest	5μ	12	4.3	S	Call for Pricing

Pentek® pH Stabilizer Inline Cartridges (Calcite & Coconut Shell Carbon)



Part Number	Model Number	Dimensions	Port Size	Micron	Case Qty	Case Wgt	Stock	Your Price
255541-43	GS-10CAL/RO-B	10" x 2"	¼" FPT	20μ	12	6.2	S	Call for Pricing
255546-43	GS-10CAL/RO-H	10" x 2"	¾" John Guest	20μ	12	6.2	S	Call for Pricing

Non-stock Pentek® Inline Filters may be ordered in case quantities.
See Page 47 for Mounting Clips.





Pentek® Replacement Components

Part Number	Model Number	Description	For Use With	Your Price
655121-96	GRO50-RC	Membrane – 50 GPD GRO	GRO-350B	Call for Pricing
655122-96	GRO75-RC	Membrane – 75 GPD GRO	GRO-475B/M, GRO-575B/M	Call for Pricing
655123-96	FDF1-RC	Filter – Chlorine Taste & Odor	F1000-DFB, All GRO Models	Call for Pricing
655120-96	F1B1-RC	Filter – Cyst and Lead, 0.5µ	F1000-B1B, GRO-475B/M	Call for Pricing
655116-96	F1S5-RC	Filter – Sediment, Polypropylene, 5 Micron	F3000-B2B/M	Call for Pricing
655126-96	F2B2-RC2	Filter – VOC, 0.5µ Twin Pack	F2000-B2B/M, F3000-B2B/M, GRO575B/M	Call for Pricing
655117-96	F1GC-RC	Filter – Post Filter	All Pentek DWS & GRO Models	Call for Pricing



Watts® ‘Quick Twist’ Cartridges



Watts® ‘Quick Twist’ Replacement Cartridges

Part Number	Description	Your Price
WQTSC-10	‘QT’ 5µ Sediment Cartridge	Call for Pricing
WQTCBC-10	‘QT’ 5µ Carbon Block Cartridge	Call for Pricing
WQTCM50-10	‘QT’ 50 GPD TFC Membrane	Call for Pricing
WQTCGAC-10	‘QT’ 10µ GAC Cartridge	Call for Pricing



Ceramic Cartridges & Candles



Doulton® Ceramic Candles

Part Number	Description	Case Qty	Your Price
W9121207	ATC SuperSterasyl (Ultra Sterasyl) Candle 7" w/ ¼" Threaded End for Gravity Filters	25	Call for Pricing
W9123053	UltraCarb Candle 10" w/ ¼" Threaded End Carbon Block Core & Lead Removal	25	Call for Pricing
W9223021	UltraCarb FRX02 Franke Candle 10" w/ ¼" Threaded End	25	Call for Pricing



Doulton® Imperial Cartridges

Part Number	Description	Case Qty	Your Price
W9220406	Doulton® Imperial Sterasyl Standard OBE Cartridge	9	Call for Pricing

See Page 80 for Gravity Filters.

Caware

MAF-14EP

HOLLOW FIBER MEMBRANE & CARBON BLOCK

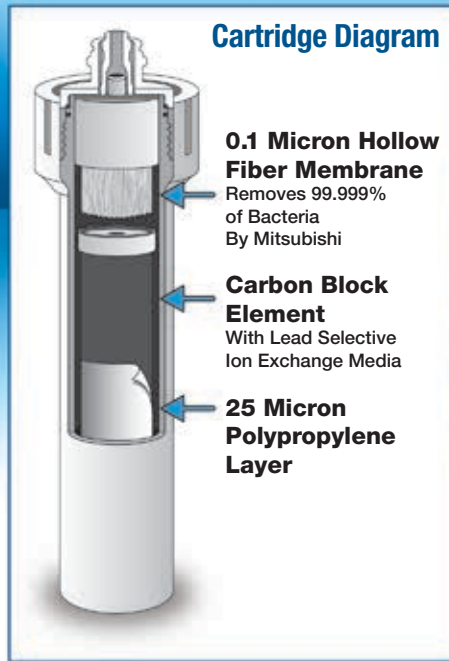

Model	Capacity	Flow	Bacterial Removal
MAF-14EP	3,000 Gal.	1 GPM	✓
H-300	300 Gal.	0.5 GPM	✗
H-104	1,000 Gal.	0.5 GPM	✗

Features:

- Removes:**
Chlorine • Taste • Odor • Cysts
• Lead • 99.999% Bacteria Removal
- Reduces:**
VOCs • THMs • Sediment/Turbidity

Operating Conditions:
Working Pressure: 5-140 psi (34-963 kpa)
Temperature: 39-100°F (4-38°C)
Flow Rate: 1.0 GPM (3.8 LPM)
Chlorine Removal Capacity: 3,000 Gallons
Lead Removal Capacity: 1,000 Gallons

Cartridge Fits in Existing Everpure QL2 & QL3 Heads

Hollow Fiber Membrane & Carbon Block Element



Part Number	Description	Case Qty	Your Price
MAF-14EP	Cartridge Replaces Everpure H-300, H-104 & Others	20	Call for Pricing
P-SB-EP	Cartridge Head, Similar to Everpure QL2, Composite Material	20	Call for Pricing
FRC-1GPM-PI010823S	3/8" MPT x 1/4" JG Male Adaptor w/ 1 GPM Flow Restrictor	N/A	Call for Pricing



Everpure Commercial Cartridges

EVERPURE®

Call for a quote on any Everpure Cartridges not shown.



Model Number	Part Number	Description	Case Qty	Your Price
MC(2)	EV9612-55	Replacement Cartridge for MC & MC(2) Systems	6	Call for Pricing
XC(2)	EV9613-97	Replacement Cartridge for XC & XC(2) Systems	6	Call for Pricing
I-2000(2)	EV9612-27	Replacement Cartridge for I-2000 & I-2000(2) Systems	6	Call for Pricing
I-4000(2)	EV9612-37	Replacement Cartridge for I-4000 & I-4000(2) Systems	6	Call for Pricing
OCS(2)	EV9618-07	0.5µ Commercial Coffee Machine Cartridge	6	Call for Pricing
BH(2)	EV9612-51	Replacement Cartridge for BH & BH(2) Systems	6	Call for Pricing
MH(2)	EV9613-26	High Capacity Commercial Coffee Machine Cartridge	6	Call for Pricing
OW200L	EV9619-06	Replacement Cartridge for QL2-OW200L Systems	6	Call for Pricing
4C	EV9601-00	14.5" Activated Cabon Cartridge for Cold Beverages	6	Call for Pricing
H965511	N/A	Hoshizaki Replacement Cartridge for HF, HC & HC-H Systems	6	Call for Pricing
SS-10	EV9799-02	Scale Reduction Cartridge for Coffee, Combo & Steamer Applications	12	Call for Pricing
SS-IMF	EV9799-32	Scale Inhibition Cartridge and Provides Corrosion Protection in Water-Fed Equipment	12	Call for Pricing
4CB5	EV9617-16	14.5" Carbon Block Cartridge	6	Call for Pricing
7CB5	EV9618-16	20.75" Carbon Block Cartridge	6	Call for Pricing
Triple-MC-2-Kit	EV9970-42	Includes: (3) MC-2 Cartridges, (1) EC210 Prefilter, (1) SS-IMF Cartridge	6	Call for Pricing
Quad-MC-2-Kit	EV9628-28	Includes: (4) MC(2) Cartridges, (1) EC210 Prefilter, (1) SS-IMF Cartridge	6	Call for Pricing
Quad-XC-2-Kit	EV9628-29	Includes: (4) XC Cartridges, (1) EC210 Prefilter, (1) SS-IMF Cartridge	6	Call for Pricing
QL2-SingleHead	EV9259-12	Everpure QL2 Single Head	12	Call for Pricing
QL3-SingleHead	EV9272-18	Everpure QL3 Single Head	12	Call for Pricing

MC²



XC²



I-2000²



I-4000²



OCS²



BH²



MH²



OW200L



4C



H965511



SS-10



4CB5



7CB5



Everpure Commercial Systems

Call for a quote on any Everpure Commercial Systems not shown.



Everpure Coldrink Fountain Dechlorinator Systems

Model Number	Part Number	Description	Flow Rate	Your Price
Coldrink1-MC2	EV9328-01	9,000 Gallon Fountain Dechlorinator System w/ Prefilter	1.67 GPM	Call for Pricing
Coldrink2-MC2	EV9328-02	18,000 Gallon Fountain Dechlorinator System w/ Prefilter	3.34 GPM	Call for Pricing
Coldrink3-MC2	EV9328-03	27,000 Gallon Fountain Dechlorinator System w/ Prefilter	5.0 GPM	Call for Pricing

Coldrink1-MC²



Coldrink2-MC²



Coldrink3-MC²



Everpure Insurice Icemaker Systems

Model Number	Part Number	Description	Flow Rate	Your Price
InsuriceSingle-I-2000-2	EV9324-01	Icemaker System w/ (1) I-2000 ² Cartridge	1.67 GPM	Call for Pricing
InsuriceTwin-I-2000-2	EV9324-02	Icemaker System w/ (2) I-2000 ² Cartridges	3.34 GPM	Call for Pricing
InsuriceTriple-I-4000-2	EV9325-03	Icemaker System w/ (3) I-4000 ² Cartridges	5.0 GPM	Call for Pricing
InsuriceQuad-I-4000-2	EV9325-04	Icemaker System w/ (4) I-4000 ² Cartridges	6.68 GPM	Call for Pricing

InsuriceSingle-I-2000²



InsuriceTwin-I-2000²



InsuriceTriple-I-4000²



InsuriceQuad-I-4000²



Everpure Coffee & Espresso Filtration Systems

Model Number	Part Number	Description	Flow Rate	Your Price
QL2-OCS2	EV9275-60	1,500 Gallon Coffee System w/ OCS2 Cartridge	0.50 GPM	Call for Pricing
QL3-BH2	EV9272-00	3,000 Gallon Coffee System w/ BH2 Cartridge	0.50 GPM	Call for Pricing
QC71-Single-MH2	EV9272-41+ EV9613-21	9,000 Gallon Coffee System w/ MH2 Cartridge	1.67 GPM	Call for Pricing

QL2-OCS²



QL3-BH²



QC71-Single-MH²



Residential Reverse Osmosis Membranes

High Recovery Membranes

Part Number	Description	Permeate to Reject Ratio	Waste Reduction	Rejection	Your Price
T112-50-XHR	50 GPD High Recovery Membrane	1:1	66-80%	98%	Call for Pricing
T112-75-XHR	75 GPD High Recovery Membrane	1:1	66-80%	98%	Call for Pricing
T112-100-XHR	100 GPD High Recovery Membrane	1:1	66-80%	98%	Call for Pricing



Pentair® GRO High Recovery Membranes

Pentair is not allowing these membranes to be sold or advertised online with pricing.



Part Number	Model Number	Description	Carbon Dimensions	Drain Flow Required	Rejection	Port Size	Case Qty	Case Wgt	Stock	Your Price
4004424	GRO-50EM w/ DLFC	50 GPD w/ Drain Flow Built-In	15.14" L x 2.50" D	150ML	96%	¼" QC	16	26.0 lbs.	S	Call for Pricing
4004425	GRO-75EM w/ DLFC	75 GPD w/ Drain Flow Built-In	15.14" L x 2.50" D	200ML	96%	¼" QC	16	27.7 lbs.	S	Call for Pricing



Pentair® Residential Membranes



Part Number	Model Number	Description	Rejection	Case Qty	Case Wgt	Your Price
655006-00	TLC-24	24 GPD Thin Film Composite Dry Membrane	98%	25	14 lbs.	Call for Pricing
655007-00	TLC-36	36 GPD Thin Film Composite Dry Membrane	98%	25	14 lbs.	Call for Pricing
555694-00	TLC-50	50 GPD Thin Film Composite Dry Membrane	98%	25	14 lbs.	Call for Pricing
555693-00	TLC-75	75 GPD Thin Film Composite Dry Membrane	98%	25	14 lbs.	Call for Pricing
655045-00	TLC-100	100 GPD Thin Film Composite Dry Membrane	98%	25	14 lbs.	Call for Pricing



CSM® Residential Membranes



Call for a quote on CSM Commercial Membranes.



Part Number	Description	Testing Press.	Rejection	Case Qty	Your Price
RE1812-24*	24 GPD Thin Film Composite Dry Membrane	60 psi	96%	25	Call for Pricing
RE1812-35*	35 GPD Thin Film Composite Dry Membrane	60 psi	96%	25	Call for Pricing
RE1812-50*	50 GPD Thin Film Composite Dry Membrane	60 psi	96%	25	Call for Pricing
RE1812-60*	60 GPD Thin Film Composite Dry Membrane	60 psi	96%	25	Call for Pricing
RE1812-80*	75/80 GPD Thin Film Composite Dry Membrane	60 psi	96%	25	Call for Pricing
RE2012-100	100 GPD Thin Film Composite Dry Membrane	60 psi	96%	25	Call for Pricing

LP (Low Pressure) Membrane produces 50 GPD at 20 psi. Perfect for low pressure applications.

*Certified by NSF to NSF/ANSI Standard 58.



DuPont Filmtec® Residential Membranes



Part Number	Description	Testing Press.	Rejection	Case Qty	Your Price
TW30-1812-50-HR	50 GPD Thin Film Composite Dry Membrane	50 psi	98%	25	Call for Pricing
BW60-1812-75	75 GPD Thin Film Composite Dry Membrane	50 psi	99%	25	Call for Pricing
TW30-1812-100-HR	100 GPD Thin Film Composite Dry Membrane	50 psi	98%	25	Call for Pricing



Hydrotech® Residential Membranes

Part Number	Model Number	Description	Case Qty	Your Price
33001071	N/A	9 GPD Thin Film Composite Dry Membrane	1	Call for Pricing
33001068	N/A	25 GPD Thin Film Composite Dry Membrane	1	Call for Pricing
33001033	N/A	50 GPD Thin Film Composite Dry Membrane	1	Call for Pricing
33001056	N/A	75 GPD Thin Film Composite Dry Membrane	1	Call for Pricing
41400004	S-FS-07	15 GPD Thin Film Composite Dry Membrane	1	Call for Pricing

See Hydrotech Sediment and Carbon Block Cartridges on Page 76.

Commercial Reverse Osmosis Membranes

Filmtec® Tap & Brackish Membranes

Part Number	Dimensions (Length x Diameter)	Flow Rate	Testing Pressure	Salt Rejection	Your Price
TW30-2026	26" x 1¾"	220 GPD	225 psi	99.0%	Call for Pricing
TW30-2514	14" x 2½"	220 GPD	225 psi	99.0%	Call for Pricing
TW30-2521	21" x 2½"	325 GPD	225 psi	99.0%	Call for Pricing
TW30-2540	40" x 2½"	850 GPD	225 psi	99.5%	Call for Pricing
BW30-2540	40" x 2½"	850 GPD	225 psi	99.0%	Call for Pricing
TW30-4014	14" x 4"	525 GPD	225 psi	99.0%	Call for Pricing
TW30-4021	21" x 4"	900 GPD	225 psi	99.0%	Call for Pricing
TW30-4040	40" x 4"	2,400 GPD	225 psi	99.5%	Call for Pricing
BW30 PRO-4040	40" x 4"	2,600 GPD	225 psi	99.5%	Call for Pricing
BW30-365	40" x 8"	9,500 GPD	225 psi	99.5%	Call for Pricing
BW30-400	40" x 8"	10,500 GPD	225 psi	99.5%	Call for Pricing
BW30-400/34i	40" x 8"	10,500 GPD	225 psi	99.5%	Call for Pricing
BW30HR-440i	40" x 8"	12,650 GPD	225 psi	99.7%	Call for Pricing

Filmtec® Low Energy Membranes

Part Number	Dimensions (Length x Diameter)	Flow Rate	Testing Pressure	Salt Rejection	Your Price
XLE-2521	21" x 2½"	365 GPD	100 psi	99.0%	Call for Pricing
XLE PRO-2540	40" x 2½"	1,200 GPD	100 psi	99.0%	Call for Pricing
XLE-4021	21" x 4"	1,025 GPD	100 psi	99.0%	Call for Pricing
XLE PRO-4040	40" x 4"	2,750 GPD	100 psi	99.0%	Call for Pricing
LCLE-PRO-4040	40" x 4"	2,500 GPD	125 psi	99.2%	Call for Pricing
XLE-440	40" x 8"	12,700 GPD	100 psi	99.0%	Call for Pricing

Filmtec® Fouling Resistant Membranes

Part Number	Dimensions (Length x Diameter)	Flow Rate	Testing Pressure	Salt Rejection	Your Price
BW30XFR-400/34i	40" x 8"	11,500 GPD	225 psi	99.65%	Call for Pricing
XFRLE-400/34i	40" x 8"	11,500 GPD	150 psi	99.4%	Call for Pricing
BW30-400/34i-FR	40" x 8"	10,500 GPD	225 psi	99.5%	Call for Pricing
BW30-400-FR	40" x 8"	10,500 GPD	225 psi	99.5%	Call for Pricing

Filmtec® Nanofiltration Membranes

Part Number	Dimensions (Length x Diameter)	Flow Rate	Testing Pressure	Salt Rejection	Your Price
NF270-2540	40" x 2½"	850 GPD	70 psi	40-60%	Call for Pricing
NF90-2540	40" x 2½"	520 GPD	70 psi	85-95%	Call for Pricing
NF-2540	40" x 2½"	2,700 GPD	130 psi	>99%	Call for Pricing
NF270-4040	40" x 4"	2,500 GPD	70 psi	40-60%	Call for Pricing
NF90-4040	40" x 4"	1,500 GPD	70 psi	85-95%	Call for Pricing
NF-4040	40" x 4"	2,700 GPD	130 psi	>99%	Call for Pricing
NF-400	40" x 8"	11,000 GPD	130 psi	>99%	Call for Pricing

Filmtec® Sea Water Desalination Membranes

Part Number	Dimensions (Length x Diameter)	Flow Rate	Testing Pressure	Salt Rejection	Your Price
SW30-2514	14" x 2½"	150 GPD	800 psi	99.4%	Call for Pricing
SW30-2521	21" x 2½"	300 GPD	800 psi	99.4%	Call for Pricing
SW30-2540	40" x 2½"	700 GPD	800 psi	99.4%	Call for Pricing
SW30-4021	21" x 4"	800 GPD	800 psi	99.4%	Call for Pricing
SW30-4040	40" x 4"	1,950 GPD	800 psi	99.4%	Call for Pricing
SW30HRLE-4040	40" x 4"	1,550 GPD	800 psi	99.4%	Call for Pricing

Filmtec® Sanitary/Full Fit (Medical, Food) Membranes

Part Number	Dimensions (Length x Diameter)	Flow Rate	Testing Pressure	Salt Rejection	Your Price
HSRO-4040-FF	40" x 4"	1,900 GPD	150 psi	99.5%	Call for Pricing
RO-4040-FF	40" x 4"	2,650 GPD	225 psi	99.5%	Call for Pricing
HSRO-390-FF	40" x 8"	9,000 GPD	150 psi	99.5%	Call for Pricing
RO-390-FF	40" x 8"	11,500 GPD	225 psi	99.5%	Call for Pricing



American Melt Blown Sediment Cartridges

Standard 9¾" × 2½" Quad Pro Gradient Density Cartridges

Part Number	Description	Micron	Case Qty	Your Price
BE1S2S1IW	9¾" × 2½" Melt Blown Polypropylene	1μ	50	Call for Pricing
BE1S2S1IW-GRV	9¾" × 2½" Grooved Melt Blown Polypropylene	1μ	50	Call for Pricing
BE5S2S1IW	9¾" × 2½" Melt Blown Polypropylene	5μ	50	Call for Pricing
BE5S2S1IW-GRV	9¾" × 2½" Grooved Melt Blown Polypropylene	5μ	50	Call for Pricing
BE10S2S1IW	9¾" × 2½" Melt Blown Polypropylene	10μ	50	Call for Pricing
BE20S2S1IW	9¾" × 2½" Melt Blown Polypropylene	20μ	50	Call for Pricing
BE20S2S1IW-GRV	9¾" × 2½" Grooved Melt Blown Polypropylene	20μ	50	Call for Pricing
BE50S2S1IW	9¾" × 2½" Melt Blown Polypropylene	50μ	50	Call for Pricing

Standard 20" × 2½" Quad Pro Gradient Density Cartridges

Part Number	Description	Micron	Case Qty	Your Price
BE1S5S1IW	20" × 2½" Melt Blown Polypropylene	1μ	25	Call for Pricing
BE5S5S1IW	20" × 2½" Melt Blown Polypropylene	5μ	25	Call for Pricing
BE5S5S1IW-GRV	20" × 2½" Grooved Melt Blown Polypropylene	5μ	25	Call for Pricing
BE10S5S1IW	20" × 2½" Melt Blown Polypropylene	10μ	25	Call for Pricing
BE20S5S1IW	20" × 2½" Melt Blown Polypropylene	20μ	25	Call for Pricing
BE50S5S1IW	20" × 2½" Melt Blown Polypropylene	50μ	25	Call for Pricing

Standard 9¾" × 4½" Quad Pro Gradient Density Cartridges

Part Number	Description	Micron	Case Qty	Your Price
BE1M2S1IW	9¾" × 4½" Melt Blown Polypropylene	1μ	12	Call for Pricing
BE5M2S1IW	9¾" × 4½" Melt Blown Polypropylene	5μ	12	Call for Pricing
BE5M2S1IW-GRV	9¾" × 4½" Grooved Melt Blown Polypropylene	5μ	12	Call for Pricing
BE20M2S1IW	9¾" × 4½" Melt Blown Polypropylene	20μ	12	Call for Pricing
BE20M2S1IW-GRV	9¾" × 4½" Grooved Melt Blown Polypropylene	20μ	12	Call for Pricing
BE50M2S1IW	9¾" × 4½" Melt Blown Polypropylene	50μ	12	Call for Pricing

Standard 20" × 4½" Quad Pro Gradient Density Cartridges

Part Number	Description	Micron	Case Qty	Your Price
BE1M5S1IW	20" × 4½" Melt Blown Polypropylene	1μ	6	Call for Pricing
BE5M5S1IW	20" × 4½" Melt Blown Polypropylene	5μ	6	Call for Pricing
BE20M5S1IW	20" × 4½" Melt Blown Polypropylene	20μ	6	Call for Pricing
BE50M5S1IW	20" × 4½" Melt Blown Polypropylene	50μ	6	Call for Pricing

Standard 30" & 40" × 2½" Quad Pro Gradient Density Cartridges

Part Number	Description	Micron	Your Price
BE1S7S1IW	30" × 2½" Melt Blown Polypropylene	1μ	Call for Pricing
BE5S7S1IW	30" × 2½" Melt Blown Polypropylene	5μ	Call for Pricing
BE20S7S1IW	30" × 2½" Melt Blown Polypropylene	20μ	Call for Pricing
BE25S7S1IW	30" × 2½" Melt Blown Polypropylene	25μ	Call for Pricing
BE5S9S1IW	40" × 2½" Melt Blown Polypropylene	5μ	Call for Pricing
BE20S9S1IW	40" × 2½" Melt Blown Polypropylene	20μ	Call for Pricing



- ◆ AMBF's Melt Blown elements are manufactured in-house with the fastest, most modern equipment ever produced, giving you the highest quality filter on the market today
- ◆ Elements are made from 1 to 100 micron in standard, high efficiency, absolute and heavy duty grades, giving you control of your filtration process
- ◆ Elements are also produced with an integrated 3 stage process yielding true depth filtration
- ◆ All elements are made with FDA compliant material for food and beverage contact under CFR Title 21
- ◆ Elements are produced in standard and custom sizes to meet all applications
- ◆ End caps are thermally welded onto the cartridge with no use of glue or other binders
- ◆ Elements are produced with 100% polypropylene or nylon materials
- ◆ Elements can be produced with or without a core depending on your application
- ◆ "BE" Melt Blown Cartridges are Tested and Certified to: NSF/ANSI 61 Standard & NSF/ANSI 42 Standard for Component

GRADIENT DENSITY MELT BLOWN POLYPROPYLENE SEDIMENT FILTERS

- ◆ Non-Branded
- ◆ No Company Markings
- ◆ Shrink Wrapped for Purity
- ◆ Micron Rating Molded into Cartridge



Graded Density	OUTER LAYER	MIDDLE LAYER	INNER LAYER
1 Micron Filter Layers	20μ	5μ	1μ
5 Micron Filter Layers	30μ	10μ	5μ
10 Micron Filter Layers	30μ	20μ	10μ
20 Micron Filter Layers	50μ	30μ	20μ
50 Micron Filter Layers	100μ	100μ	50μ

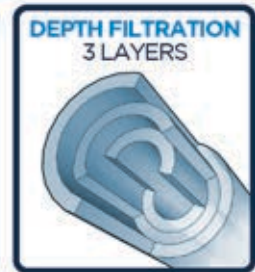

Melt Blown Polypropylene Sediment Cartridges

Standard 9 7/8" x 2 1/2" Gradient Density Sediment Cartridges



Part Number	Description	Micron	Case Qty	Case Wgt	Your Price
LF-PP-00.5-249	9 7/8" x 2 1/2" Melt Blown Polypropylene	0.5μ	50	17 lbs.	Call for Pricing
LF-PP-001-249	9 7/8" x 2 1/2" Melt Blown Polypropylene	1μ	50	17 lbs.	Call for Pricing
LF-PP-005-249	9 7/8" x 2 1/2" Melt Blown Polypropylene	5μ	50	17 lbs.	Call for Pricing
LF-PP-010-249	9 7/8" x 2 1/2" Melt Blown Polypropylene	10μ	50	17 lbs.	Call for Pricing
LF-PP-020-249	9 7/8" x 2 1/2" Melt Blown Polypropylene	20μ	50	17 lbs.	Call for Pricing
LF-PP-050-249	9 7/8" x 2 1/2" Melt Blown Polypropylene	50μ	50	17 lbs.	Call for Pricing

Standard 20" x 2 1/2" Gradient Density Sediment Cartridges



Part Number	Description	Micron	Case Qty	Case Wgt	Your Price
LF-PP-001-508	20" x 2 1/2" Melt Blown Polypropylene	1μ	25	17 lbs.	Call for Pricing
LF-PP-005-508	20" x 2 1/2" Melt Blown Polypropylene	5μ	25	17 lbs.	Call for Pricing
LF-PP-010-508	20" x 2 1/2" Melt Blown Polypropylene	10μ	25	17 lbs.	Call for Pricing
LF-PP-020-508	20" x 2 1/2" Melt Blown Polypropylene	20μ	25	17 lbs.	Call for Pricing
LF-PP-050-508	20" x 2 1/2" Melt Blown Polypropylene	50μ	25	17 lbs.	Call for Pricing

Full Flow/BB 9 7/8" x 4 1/2" Gradient Density Sediment Cartridges



Part Number	Description	Micron	Case Qty	Case Wgt	Your Price
LF-PP-001-249-B	9 7/8" x 4 1/2" Melt Blown Polypropylene	1μ	18	18 lbs.	Call for Pricing
LF-PP-005-249-B	9 7/8" x 4 1/2" Melt Blown Polypropylene	5μ	18	18 lbs.	Call for Pricing
LF-PP-020-249-B	9 7/8" x 4 1/2" Melt Blown Polypropylene	20μ	18	18 lbs.	Call for Pricing
LF-PP-050-249-B	9 7/8" x 4 1/2" Melt Blown Polypropylene	50μ	18	18 lbs.	Call for Pricing

Full Flow/BB 20" x 4 1/2" Gradient Density Sediment Cartridges



Part Number	Description	Micron	Case Qty	Case Wgt	Your Price
LF-PP-001-508-B	20" x 4 1/2" Melt Blown Polypropylene	1μ	9	18 lbs.	Call for Pricing
LF-PP-005-508-B	20" x 4 1/2" Melt Blown Polypropylene	5μ	9	18 lbs.	Call for Pricing
LF-PP-020-508-B	20" x 4 1/2" Melt Blown Polypropylene	20μ	9	18 lbs.	Call for Pricing
LF-PP-050-508-B	20" x 4 1/2" Melt Blown Polypropylene	50μ	9	18 lbs.	Call for Pricing

30" x 2 1/2" Gradient Density Sediment Cartridges



Part Number	Description	Micron	Case Qty	Case Wgt	Your Price
LF-PP-001-762	30" x 2 1/2" Melt Blown Polypropylene	1μ	25	24 lbs.	Call for Pricing
LF-PP-005-762	30" x 2 1/2" Melt Blown Polypropylene	5μ	25	24 lbs.	Call for Pricing
LF-PP-020-762	30" x 2 1/2" Melt Blown Polypropylene	20μ	25	24 lbs.	Call for Pricing

40" x 2 1/2" Gradient Density Sediment Cartridges

Part Number	Description	Micron	Case Qty	Case Wgt	Your Price
LF-PP-005-1016	40" x 2 1/2" Melt Blown Polypropylene	5μ	25	33 lbs.	Call for Pricing
LF-PP-020-1016	40" x 2 1/2" Melt Blown Polypropylene	20μ	25	33 lbs.	Call for Pricing



GROOVED GRADIENT DENSITY MELT BLOWN POLYPROPYLENE SEDIMENT FILTERS

Grooved cartridges have increased surface area for longer life and better performance.

Compare to CUNO/Aquapure and save!



Graded Density	OUTER LAYER	INNER LAYER
1 Micron Filter Layers	10-15µ	1µ
5 Micron Filter Layers	10-15µ	5µ
20 Micron Filter Layers	25-30µ	20µ



Grooved Melt Blown Polypropylene Sediment Cartridges

10" x 2½" Grooved Gradient Density Melt Blown Polypropylene Sediment Cartridges

Part Number	Description	Micron	Case Qty	Case Wgt	Your Price
LF-PP-001-249-G	9¾" x 2½" Grooved Melt Blown Polypropylene	1µ	50	16 lbs.	Call for Pricing
LF-PP-005-249-G	9¾" x 2½" Grooved Melt Blown Polypropylene	5µ	50	16 lbs.	Call for Pricing
LF-PP-020-249-G	9¾" x 2½" Grooved Melt Blown Polypropylene	20µ	50	16 lbs.	Call for Pricing

20" x 2½" Grooved Gradient Density Melt Blown Polypropylene Sediment Cartridges

Part Number	Description	Micron	Case Qty	Case Wgt	Your Price
LF-PP-005-508-G	20" x 2½" Grooved Melt Blown Polypropylene	5µ	25	16 lbs.	Call for Pricing

10" x 4½" Grooved Gradient Density Melt Blown Polypropylene Sediment Cartridges

Part Number	Description	Micron	Case Qty	Case Wgt	Your Price
LF-PP-005-249-B-G	9¾" x 4½" Grooved Melt Blown Polypropylene	5µ	18	17 lbs.	Call for Pricing
LF-PP-020-249-B-G	9¾" x 4½" Grooved Melt Blown Polypropylene	20µ	18	17 lbs.	Call for Pricing



Pentek® Melt Blown & Pleated Sediment Cartridges

Pentek® Standard Melt Blown Sediment Cartridges

Part Number	Model Number	Description	Micron	Case Qty	Case Wgt	Your Price
155225-43	P1	9¾" x 2¾" Spun Polypropylene	1µ	24	10.1 lbs.	Call for Pricing
155014-43	P5	9¾" x 2¾" Spun Polypropylene	5µ	24	9.4 lbs.	Call for Pricing
155015-43	P25	9¾" x 2¾" Spun Polypropylene	25µ	24	8.5 lbs.	Call for Pricing
155304-43	P1-20	20" x 2¾" Spun Polypropylene	1µ	20	15.6 lbs.	Call for Pricing
155016-43	P5-20	20" x 2¾" Spun Polypropylene	5µ	20	15.6 lbs.	Call for Pricing
155226-43	P25-20	20" x 2¾" Spun Polypropylene	25µ	20	15.6 lbs.	Call for Pricing
155749-43	PD-5-934	9¾" x 2¾" Grooved Spun Polypropylene	5µ			Call for Pricing

Pentek® Big Blue® Melt Blown Sediment Cartridges

Part Number	Model Number	Description	Micron	Case Qty	Case Wgt	Your Price
155359-43	DGD-2501	10" x 4½" Dual Gradient Polypropylene	25/1µ	8	10 lbs.	Call for Pricing
155357-43	DGD-5005	10" x 4½" Dual Gradient Polypropylene	50/5µ	8	10 lbs.	Call for Pricing
155355-43	DGD-7525	10" x 4½" Dual Gradient Polypropylene	75/25µ	8	10 lbs.	Call for Pricing
155360-43	DGD-2501-20	20" x 4½" Dual Gradient Polypropylene	25/1µ	6	23 lbs.	Call for Pricing
155358-43	DGD-5005-20	20" x 4½" Dual Gradient Polypropylene	50/5µ	6	23 lbs.	Call for Pricing
155356-43	DGD-7525-20	20" x 4½" Dual Gradient Polypropylene	75/25µ	6	23 lbs.	Call for Pricing

Pentek® Pleated Sediment Cartridges

Part Number	Model Number	Description	Micron	Case Qty	Case Wgt	Your Price
155001-43	S1	9¾" x 2¾" Pleated Cellulose	20µ	24	8.8 lbs.	Call for Pricing
155303-43	S1-20	20" x 2¾" Pleated Cellulose	20µ	14	14 lbs.	Call for Pricing
155101-43	R30-BB	10" x 4½" Pleated Cellulose	30µ	8	8.5 lbs.	Call for Pricing
155053-43	R50-BB	10" x 4½" Pleated Cellulose	50µ	8	8.5 lbs.	Call for Pricing
155430-43	R30-20BB	20" x 4½" Pleated Cellulose	30µ	6	10 lbs.	Call for Pricing
255494-43	ECP5-20BB	20" x 4½" Pleated Cellulose	5µ	6	10 lbs.	Call for Pricing



Shelco® String Wound Sediment Cartridges

Shelco® has created the MicroSentry™ cartridge, setting a higher standard for industries requiring cartridge filtration. Shelco® equipment makes achieving precision patterns a matter of standard procedure. State of the art computerized production machinery takes the variables out of custom winding and enables production of filter cartridges that are accurately wound from a single strand of specially selected fibrous roving material, wound around a perforated core in a nearly perfect geometric pattern.



10" x 2½" String Wound FDA Polypropylene Sediment Cartridges



Part Number	Description	Micron	Case Qty	Case Wgt	Stock	Your Price
MS10FP0.5-B-T	10" x 2½" String Wound Polypropylene	0.5µ	30	12 lbs.	S	Call for Pricing
MS10FP1-B-T	10" x 2½" String Wound Polypropylene	1µ	30	12 lbs.	S	Call for Pricing
MS10FP5-B-T	10" x 2½" String Wound Polypropylene	5µ	30	12 lbs.	S	Call for Pricing
MS10FP10-B-T	10" x 2½" String Wound Polypropylene	10µ	30	12 lbs.	S	Call for Pricing
MS10FP20-B-T	10" x 2½" String Wound Polypropylene	20µ	30	12 lbs.	NS	Call for Pricing
MS10FP50-B-T	10" x 2½" String Wound Polypropylene	50µ	30	12 lbs.	S	Call for Pricing
MS10FP100-B-T	10" x 2½" String Wound Polypropylene	100µ	30	12 lbs.	NS	Call for Pricing

20" x 2½" String Wound FDA Polypropylene Sediment Cartridges



Part Number	Description	Micron	Case Qty	Case Wgt	Stock	Your Price
MS20FP0.5-B-T	20" x 2½" String Wound Polypropylene	0.5µ	15	11 lbs.	NS	Call for Pricing
MS20FP1-B-T	20" x 2½" String Wound Polypropylene	1µ	15	11 lbs.	S	Call for Pricing
MS20FP5-B-T	20" x 2½" String Wound Polypropylene	5µ	15	11 lbs.	S	Call for Pricing
MS20FP10-B-T	20" x 2½" String Wound Polypropylene	10µ	15	11 lbs.	NS	Call for Pricing
MS20FP20-B-T	20" x 2½" String Wound Polypropylene	20µ	15	11 lbs.	NS	Call for Pricing
MS20FP50-B-T	20" x 2½" String Wound Polypropylene	50µ	15	11 lbs.	S	Call for Pricing
MS20FP100-B-T	20" x 2½" String Wound Polypropylene	100µ	15	11 lbs.	NS	Call for Pricing

10" x 4½" String Wound FDA Polypropylene Sediment Cartridges



Part Number	Description	Micron	Case Qty	Case Wgt	Stock	Your Price
MS10FP1-45-B-T	10" x 4½" String Wound Polypropylene	1µ	8	15 lbs.	S	Call for Pricing
MS10FP5-45-B-T	10" x 4½" String Wound Polypropylene	5µ	8	15 lbs.	S	Call for Pricing
MS10FP10-45-B-T	10" x 4½" String Wound Polypropylene	10µ	8	15 lbs.	NS	Call for Pricing
MS10FP20-45-B-T	10" x 4½" String Wound Polypropylene	20µ	8	15 lbs.	NS	Call for Pricing
MS10FP50-45-B-T	10" x 4½" String Wound Polypropylene	50µ	8	15 lbs.	S	Call for Pricing
MS10FP100-45-B-T	10" x 4½" String Wound Polypropylene	100µ	8	15 lbs.	NS	Call for Pricing

20" x 4½" String Wound FDA Polypropylene Sediment Cartridges



Part Number	Description	Micron	Case Qty	Case Wgt	Stock	Your Price
MS10FP1-45-B-T	10" x 4½" String Wound Polypropylene	1µ	8	15 lbs.	S	Call for Pricing
MS10FP5-45-B-T	10" x 4½" String Wound Polypropylene	5µ	8	15 lbs.	S	Call for Pricing
MS10FP10-45-B-T	10" x 4½" String Wound Polypropylene	10µ	8	15 lbs.	NS	Call for Pricing
MS10FP20-45-B-T	10" x 4½" String Wound Polypropylene	20µ	8	15 lbs.	NS	Call for Pricing
MS10FP50-45-B-T	10" x 4½" String Wound Polypropylene	50µ	8	15 lbs.	S	Call for Pricing
MS10FP100-45-B-T	10" x 4½" String Wound Polypropylene	100µ	8	15 lbs.	NS	Call for Pricing

30" x 2½" String Wound FDA Polypropylene Sediment Cartridges



Part Number	Description	Micron	Case Qty	Case Wgt	Stock	Your Price
MS30FP0.5-B-T	30" x 2½" String Wound Polypropylene	0.5µ	15	18 lbs.	NS	Call for Pricing
MS30FP1-B-T	30" x 2½" String Wound Polypropylene	1µ	15	18 lbs.	NS	Call for Pricing
MS30FP5-B-T	30" x 2½" String Wound Polypropylene	5µ	15	18 lbs.	NS	Call for Pricing
MS30FP10-B-T	30" x 2½" String Wound Polypropylene	10µ	15	18 lbs.	NS	Call for Pricing
MS30FP20-B-T	30" x 2½" String Wound Polypropylene	20µ	15	18 lbs.	NS	Call for Pricing
MS30FP50-B-T	30" x 2½" String Wound Polypropylene	50µ	15	18 lbs.	NS	Call for Pricing
MS30FP100-B-T	30" x 2½" String Wound Polypropylene	100µ	15	18 lbs.	NS	Call for Pricing

40" x 2½" String Wound FDA Polypropylene Sediment Cartridges



Part Number	Description	Micron	Case Qty	Case Wgt	Stock	Your Price
MS40FP0.5-B-T	40" x 2½" String Wound Polypropylene	0.5µ	10	21 lbs.	NS	Call for Pricing
MS40FP1-B-T	40" x 2½" String Wound Polypropylene	1µ	10	21 lbs.	NS	Call for Pricing
MS40FP5-B-T	40" x 2½" String Wound Polypropylene	5µ	10	21 lbs.	NS	Call for Pricing
MS40FP10-B-T	40" x 2½" String Wound Polypropylene	10µ	10	21 lbs.	NS	Call for Pricing
MS40FP20-B-T	40" x 2½" String Wound Polypropylene	20µ	10	21 lbs.	NS	Call for Pricing
MS40FP50-B-T	40" x 2½" String Wound Polypropylene	50µ	10	21 lbs.	NS	Call for Pricing
MS40FP100-B-T	40" x 2½" String Wound Polypropylene	100µ	10	21 lbs.	NS	Call for Pricing

All non-stock Shelco cartridges are drop-shipped and are only available in full cases.



High Temperature Sediment Cartridges

10" High Temperature Sediment Cartridges w/ Stainless Steel Core for up to 180° F



Part Number	Description	Material	Micron	Case Qty	Case Wgt	Stock	Your Price
MS10FS0.5-B-T	10" x 2½" High Temp. String Wound	Polypropylene	0.5µ	30	14 lbs.	NS	Call for Pricing
MS10FS1-B-T	10" x 2½" High Temp. String Wound	Polypropylene	1µ	30	14 lbs.	NS	Call for Pricing
MS10FS5-B-T	10" x 2½" High Temp. String Wound	Polypropylene	5µ	30	14 lbs.	S	Call for Pricing
MS10FS10-B-T	10" x 2½" High Temp. String Wound	Polypropylene	10µ	30	14 lbs.	S	Call for Pricing
MS10FS20-B-T	10" x 2½" High Temp. String Wound	Polypropylene	20µ	30	14 lbs.	NS	Call for Pricing
MS10FS50-B-T	10" x 2½" High Temp. String Wound	Polypropylene	50µ	30	14 lbs.	S	Call for Pricing
MS10FS100-B-T	10" x 2½" High Temp. String Wound	Polypropylene	100µ	30	14 lbs.	NS	Call for Pricing

20" High Temperature Sediment Cartridges w/ Stainless Steel Core for up to 180° F



Part Number	Description	Material	Micron	Case Qty	Case Wgt	Stock	Your Price
MS20FS0.5-B-T	20" x 2½" High Temp. String Wound	Polypropylene	0.5µ	15	17 lbs.	NS	Call for Pricing
MS20FS1-B-T	20" x 2½" High Temp. String Wound	Polypropylene	1µ	15	17 lbs.	NS	Call for Pricing
MS20FS5-B-T	20" x 2½" High Temp. String Wound	Polypropylene	5µ	15	17 lbs.	S	Call for Pricing
MS20FS10-B-T	20" x 2½" High Temp. String Wound	Polypropylene	10µ	15	17 lbs.	NS	Call for Pricing
MS20FS20-B-T	20" x 2½" High Temp. String Wound	Polypropylene	20µ	15	17 lbs.	NS	Call for Pricing
MS20FS50-B-T	20" x 2½" High Temp. String Wound	Polypropylene	50µ	15	17 lbs.	S	Call for Pricing
MS20FS100-B-T	20" x 2½" High Temp. String Wound	Polypropylene	100µ	15	17 lbs.	NS	Call for Pricing

20" x 4½" High Temp. Sediment Cartridge w/ Stainless Steel Core for up to 180° F*

Part Number	Description	Micron	Case Qty	Case Wgt	Stock	Your Price
MS20FS45-B-T	20" x 4½" High Temp. String Wound	5µ	4	11.6 lbs.	NS	Call for Pricing

30" High Temperature Sediment Cartridges w/ Stainless Steel Core for up to 180° F*



Part Number	Description	Micron	Case Qty	Case Wgt	Stock	Your Price
MS30FS.5-B-T	30" x 2½" High Temp. String Wound	0.5µ	15	21 lbs.	NS	Call for Pricing
MS30FS1-B-T	30" x 2½" High Temp. String Wound	1µ	15	21 lbs.	NS	Call for Pricing
MS30FS5-B-T	30" x 2½" High Temp. String Wound	5µ	15	21 lbs.	NS	Call for Pricing
MS30FS10-B-T	30" x 2½" High Temp. String Wound	10µ	15	21 lbs.	NS	Call for Pricing
MS30FS20-B-T	30" x 2½" High Temp. String Wound	20µ	15	21 lbs.	NS	Call for Pricing
MS30FS50-B-T	30" x 2½" High Temp. String Wound	50µ	15	21 lbs.	NS	Call for Pricing
MS30FS100-B-T	30" x 2½" High Temp. String Wound	100µ	15	21 lbs.	NS	Call for Pricing

40" High Temperature Sediment Cartridges w/ Stainless Steel Core for up to 180° F*



Part Number	Description	Micron	Case Qty	Case Wgt	Stock	Your Price
MS40FS.5-B-T	40" x 2½" High Temp. String Wound	0.5µ	10	23 lbs.	NS	Call for Pricing
MS40FS1-B-T	40" x 2½" High Temp. String Wound	1µ	10	23 lbs.	NS	Call for Pricing
MS40FS5-B-T	40" x 2½" High Temp. String Wound	5µ	10	23 lbs.	NS	Call for Pricing
MS40FS10-B-T	40" x 2½" High Temp. String Wound	10µ	10	23 lbs.	NS	Call for Pricing
MS40FS20-B-T	40" x 2½" High Temp. String Wound	20µ	10	23 lbs.	NS	Call for Pricing
MS40FS50-B-T	40" x 2½" High Temp. String Wound	50µ	10	23 lbs.	NS	Call for Pricing
MS40FS100-B-T	40" x 2½" High Temp. String Wound	100µ	10	23 lbs.	NS	Call for Pricing

*30" & 40" Cartridges are available for drop shipment, in full cases only. Call for a quote on BB/Full Flow size high temperature cartridges.



Pentek® Pleated Sediment Cartridges



Part Number	Model Number	Description	Micron	Flow Rate	Case Qty	Your Price
255482-43	ECP5-10	10" x 2½" Pleated Cellulose/Polyester	5µ	10 GPM	24	Call for Pricing
255481-43	ECP1-10	10" x 2½" Pleated Cellulose/Polyester	1µ	10 GPM	24	Call for Pricing
255490-43	ECP5-BB	10" x 4½" Pleated Cellulose/Polyester	5µ	20 GPM	8	Call for Pricing

Harmsco® Standard 9¾" × 2¾" Pleated Sediment Cartridges



Part Number	Description	Micron	Media (sq ft)	Flow Rate	Case Qty	Case Wgt	Stock	Your Price
PP-S-1	9¾" × 2¾" Polyester-Plus™ Filter Media	1µ Absolute	3.7	1.85 GPM	24	9 lbs.	S	Call for Pricing
WB-0.35W	9¾" × 2¾" WaterBetter® Filter Media	0.35µ	4	4 GPM	24	9 lbs.	S	Call for Pricing
WB-1W	9¾" × 2¾" WaterBetter® Filter Media	1µ	4	4 GPM	24	9 lbs.	S	Call for Pricing
WB-5W	9¾" × 2¾" WaterBetter® Filter Media	5µ	4	4 GPM	24	9 lbs.	S	Call for Pricing
WB-10W	9¾" × 2¾" WaterBetter® Filter Media	10µ	4	4 GPM	24	9 lbs.	S	Call for Pricing
WB-20W	9¾" × 2¾" WaterBetter® Filter Media	20µ	4	4 GPM	24	9 lbs.	S	Call for Pricing
WB-50W	9¾" × 2¾" WaterBetter® Filter Media	50µ	4	4 GPM	24	9 lbs.	S	Call for Pricing
801-0.35W	9¾" × 2¾" Polyester-Plus™ Filter Media	0.35µ	6	6 GPM	24	11 lbs.	S	Call for Pricing
801-1W	9¾" × 2¾" Polyester-Plus™ Filter Media	1µ	6	6 GPM	24	11 lbs.	S	Call for Pricing
801-5W	9¾" × 2¾" Polyester-Plus™ Filter Media	5µ	6	6 GPM	24	11 lbs.	S	Call for Pricing
801-10W	9¾" × 2¾" Polyester-Plus™ Filter Media	10µ	6	6 GPM	24	11 lbs.	S	Call for Pricing
801-20W	9¾" × 2¾" Polyester-Plus™ Filter Media	20µ	6	6 GPM	24	11 lbs.	S	Call for Pricing
801-50W	9¾" × 2¾" Polyester-Plus™ Filter Media	50µ	6	6 GPM	24	11 lbs.	S	Call for Pricing
801-100W	9¾" × 2¾" Polyester-Plus™ Filter Media	100µ	6	6 GPM	24	11 lbs.	NS	Call for Pricing

Harmsco® Standard 20" × 2¾" Pleated Sediment Cartridges



Part Number	Description	Micron	Media (sq ft)	Flow Rate	Case Qty	Case Wgt	Stock	Your Price
PP-701-1/20	20" × 2¾" Absolute Poly-Pleat™ Filter Media	1µ Absolute	7	3.5 GPM	28	14 lbs.	S	Call for Pricing
WB-20-0.35W	20" × 2¾" WaterBetter® Filter Media	0.35µ	8	8 GPM	24	14 lbs.	S	Call for Pricing
WB-20-1W	20" × 2¾" WaterBetter® Filter Media	1µ	8	8 GPM	24	14 lbs.	S	Call for Pricing
WB-20-5W	20" × 2¾" WaterBetter® Filter Media	5µ	8	8 GPM	24	14 lbs.	S	Call for Pricing
WB-20-10W	20" × 2¾" WaterBetter® Filter Media	10µ	8	8 GPM	24	15 lbs.	S	Call for Pricing
WB-20-20W	20" × 2¾" WaterBetter® Filter Media	20µ	8	8 GPM	24	14 lbs.	S	Call for Pricing
WB-20-50W	20" × 2¾" WaterBetter® Filter Media	50µ	8	8 GPM	24	15 lbs.	S	Call for Pricing
801-0.35-20W	20" × 2¾" Polyester-Plus™ Filter Media	0.35µ	12	12 GPM	24	18 lbs.	S	Call for Pricing
801-1-20W	20" × 2¾" Polyester-Plus™ Filter Media	1µ	12	12 GPM	24	17 lbs.	S	Call for Pricing
801-5-20W	20" × 2¾" Polyester-Plus™ Filter Media	5µ	12	12 GPM	24	17 lbs.	S	Call for Pricing
801-10-20W	20" × 2¾" Polyester-Plus™ Filter Media	10µ	12	12 GPM	24	18 lbs.	S	Call for Pricing
801-20-20W	20" × 2¾" Polyester-Plus™ Filter Media	20µ	12	12 GPM	24	18 lbs.	S	Call for Pricing
801-50-20W	20" × 2¾" Polyester-Plus™ Filter Media	50µ	12	12 GPM	24	17 lbs.	NS	Call for Pricing
801-100-20W	20" × 2¾" Polyester-Plus™ Filter Media	100µ	12	12 GPM	24	17 lbs.	NS	Call for Pricing

Harmsco® Calypso Blue™ Full-Flow/BB 10" × 4½" Pleated Sediment Cartridges



Part Number	Description	Micron	Media (sq ft)	Flow Rate	Case Qty	Case Wgt	Stock	Your Price
PP-BB-10-1	10" × 4½" Poly-Pleat® Filter Media	1µ Absolute	8	4 GPM	8	7 lbs.	S	Call for Pricing
WB-HB-10-0.35W	10" × 4½" WaterBetter® Filter Media	0.35µ	9.5	10 GPM	8	7 lbs.	S	Call for Pricing
WB-HB-10-1W	10" × 4½" WaterBetter® Filter Media	1µ	9.5	10 GPM	8	7 lbs.	S	Call for Pricing
WB-HB-10-5W	10" × 4½" WaterBetter® Filter Media	5µ	9.5	10 GPM	8	7 lbs.	S	Call for Pricing
WB-HB-10-10W	10" × 4½" WaterBetter® Filter Media	10µ	9.5	10 GPM	8	7 lbs.	S	Call for Pricing
WB-HB-10-20W	10" × 4½" WaterBetter® Filter Media	20µ	9.5	10 GPM	8	7 lbs.	S	Call for Pricing
WB-HB-10-50W	10" × 4½" WaterBetter® Filter Media	50µ	9.5	10 GPM	8	7 lbs.	S	Call for Pricing



Harmsco® Calypso Blue™ Full-Flow/BB 20" × 4½" Pleated Sediment Cartridges

Part Number	Description	Micron	Media (sq ft)	Flow Rate	Case Qty	Case Wgt	Stock	Your Price
PP-BB-20-1	20" × 4½" Poly-Pleat® Filter Media	1µ Absolute	20	10 GPM	4	6 lbs.	S	Call for Pricing
WB-HB-20-0.35W	20" × 4½" WaterBetter® Filter Media	0.35µ	21	20 GPM	4	6 lbs.	S	Call for Pricing
WB-HB-20-1W	20" × 4½" WaterBetter® Filter Media	1µ	21	20 GPM	4	6 lbs.	S	Call for Pricing
WB-HB-20-5W	20" × 4½" WaterBetter® Filter Media	5µ	21	20 GPM	4	6 lbs.	S	Call for Pricing
WB-HB-20-10W	20" × 4½" WaterBetter® Filter Media	10µ	21	20 GPM	4	6 lbs.	S	Call for Pricing
WB-HB-20-20W	20" × 4½" WaterBetter® Filter Media	20µ	21	20 GPM	4	6 lbs.	S	Call for Pricing
WB-HB-20-50W	20" × 4½" WaterBetter® Filter Media	50µ	21	20 GPM	4	6 lbs.	S	Call for Pricing

Any Harmsco cartridges not listed can be ordered for you in case quantities.

0.35µ 1µ 5µ 10µ 20µ 50µ 100µ



Harmsco® Hurricane® Filter Cartridges - Model 40

Part Number	Description	Micron	Media (sq ft)	Flow Rate	Case Qty	Stock	Your Price
HC-40-0.35	9½" x 7¾" Hurricane™ Polyester Filter Media	0.35µ	40	35 GPM	1	NS	Call for Pricing
HC-40-1	9½" x 7¾" Hurricane™ Polyester Filter Media	1µ	40	35 GPM	1	S	Call for Pricing
HC-40-5	9½" x 7¾" Hurricane™ Polyester Filter Media	5µ	40	35 GPM	1	S	Call for Pricing
HC-40-10	9½" x 7¾" Hurricane™ Polyester Filter Media	10µ	40	35 GPM	1	NS	Call for Pricing
HC-40-20	9½" x 7¾" Hurricane™ Polyester Filter Media	20µ	40	35 GPM	1	S	Call for Pricing
HC-40-50	9½" x 7¾" Hurricane™ Polyester Filter Media	50µ	40	35 GPM	1	NS	Call for Pricing
HC-40-100	9½" x 7¾" Hurricane™ Polyester Filter Media	100µ	40	35 GPM	1	NS	Call for Pricing
HC-40-150	9½" x 7¾" Hurricane™ Polyester Filter Media	150µ	40	35 GPM	1	NS	Call for Pricing

Harmsco® Hurricane® Filter Cartridges - Model 90

Part Number	Description	Micron	Media (sq ft)	Flow Rate	Case Qty	Stock	Your Price
HC-90-0.35	19½" x 7¾" Hurricane™ Polyester Filter Media	0.35µ	90	70 GPM	1	NS	Call for Pricing
HC-90-1	19½" x 7¾" Hurricane™ Polyester Filter Media	1µ	90	70 GPM	1	S	Call for Pricing
HC-90-5	19½" x 7¾" Hurricane™ Polyester Filter Media	5µ	90	70 GPM	1	NS	Call for Pricing
HC-90-10	19½" x 7¾" Hurricane™ Polyester Filter Media	10µ	90	70 GPM	1	S	Call for Pricing
HC-90-20	19½" x 7¾" Hurricane™ Polyester Filter Media	20µ	90	70 GPM	1	S	Call for Pricing
HC-90-50	19½" x 7¾" Hurricane™ Polyester Filter Media	50µ	90	70 GPM	1	S	Call for Pricing
HC-90-100	19½" x 7¾" Hurricane™ Polyester Filter Media	100µ	90	70 GPM	1	S	Call for Pricing
HC-90-150	19½" x 7¾" Hurricane™ Polyester Filter Media	150µ	90	70 GPM	1	S	Call for Pricing

Harmsco® Hurricane® Filter Cartridges - Model 170

Part Number	Description	Micron	Media (sq ft)	Flow Rate	Case Qty	Stock	Your Price
HC-170-0.35	30¾" x 7¾" Hurricane™ Polyester Filter Media	0.35µ	170	105 GPM	1	S	Call for Pricing
HC-170-1	30¾" x 7¾" Hurricane™ Polyester Filter Media	1µ	170	105 GPM	1	S	Call for Pricing
HC-170-5	30¾" x 7¾" Hurricane™ Polyester Filter Media	5µ	170	105 GPM	1	S	Call for Pricing
HC-170-10	30¾" x 7¾" Hurricane™ Polyester Filter Media	10µ	170	105 GPM	1	S	Call for Pricing
HC-170-20	30¾" x 7¾" Hurricane™ Polyester Filter Media	20µ	170	105 GPM	1	S	Call for Pricing
HC-170-50	30¾" x 7¾" Hurricane™ Polyester Filter Media	50µ	170	105 GPM	1	S	Call for Pricing
HC-170-100	30¾" x 7¾" Hurricane™ Polyester Filter Media	100µ	170	105 GPM	1	NS	Call for Pricing
HC-170-150	30¾" x 7¾" Hurricane™ Polyester Filter Media	150µ	170	105 GPM	1	NS	Call for Pricing

Harmsco® Standard 19½" x 2¾" Pleated Sediment Cartridges

Part Number	Description	Micron	Media (sq ft)	Flow Rate	Case Qty	Stock	Your Price
921-0.35W	19½" x 2¾" Polyester-Plus™ Filter Media	0.35µ	12	12 GPM	24	NS	Call for Pricing
921-1W	19½" x 2¾" Polyester-Plus™ Filter Media	1µ	12	12 GPM	24	NS	Call for Pricing
921-5W	19½" x 2¾" Polyester-Plus™ Filter Media	5µ	12	12 GPM	24	NS	Call for Pricing
921-10W	19½" x 2¾" Polyester-Plus™ Filter Media	10µ	12	12 GPM	24	NS	Call for Pricing
921-20W	19½" x 2¾" Polyester-Plus™ Filter Media	20µ	12	12 GPM	24	NS	Call for Pricing
921-50W	19½" x 2¾" Polyester-Plus™ Filter Media	50µ	12	12 GPM	24	NS	Call for Pricing
921-100W	19½" x 2¾" Polyester-Plus™ Filter Media	100µ	12	12 GPM	24	NS	Call for Pricing

Harmsco® Standard 29½" x 2¾" Pleated Sediment Cartridges

Part Number	Description	Micron	Media (sq ft)	Flow Rate	Case Qty	Stock	Your Price
931-0.35W	29½" x 2¾" Polyester-Plus™ Filter Media	0.35µ	18	18 GPM	24	NS	Call for Pricing
931-1W	29½" x 2¾" Polyester-Plus™ Filter Media	1µ	18	18 GPM	24	NS	Call for Pricing
931-5W	29½" x 2¾" Polyester-Plus™ Filter Media	5µ	18	18 GPM	24	NS	Call for Pricing
931-10W	29½" x 2¾" Polyester-Plus™ Filter Media	10µ	18	18 GPM	24	NS	Call for Pricing
931-20W	29½" x 2¾" Polyester-Plus™ Filter Media	20µ	18	18 GPM	24	NS	Call for Pricing
931-50W	29½" x 2¾" Polyester-Plus™ Filter Media	50µ	18	18 GPM	24	NS	Call for Pricing
931-100W	29½" x 2¾" Polyester-Plus™ Filter Media	100µ	18	18 GPM	24	NS	Call for Pricing

Harmsco® Standard 30" x 2¾" Pleated Sediment Cartridges

Part Number	Description	Micron	Media (sq ft)	Flow Rate	Case Qty	Stock	Your Price
801-0.35-30W	30" x 2¾" Polyester-Plus™ Filter Media	0.35µ	18	18 GPM	24	NS	Call for Pricing
801-1-30W	30" x 2¾" Polyester-Plus™ Filter Media	1µ	18	18 GPM	24	NS	Call for Pricing
801-5-30W	30" x 2¾" Polyester-Plus™ Filter Media	5µ	18	18 GPM	24	NS	Call for Pricing
801-10-30W	30" x 2¾" Polyester-Plus™ Filter Media	10µ	18	18 GPM	24	NS	Call for Pricing
801-20-30W	30" x 2¾" Polyester-Plus™ Filter Media	20µ	18	18 GPM	24	NS	Call for Pricing
801-50-30W	30" x 2¾" Polyester-Plus™ Filter Media	50µ	18	18 GPM	24	NS	Call for Pricing

Harmsco® Standard 40" x 2¾" Pleated Sediment Cartridges

Part Number	Description	Micron	Media (sq ft)	Flow Rate	Case Qty	Stock	Your Price
801-0.35-40W	40" x 2¾" Polyester-Plus™ Filter Media	0.35µ	24	24 GPM	24	NS	Call for Pricing
801-1-40W	40" x 2¾" Polyester-Plus™ Filter Media	1µ	24	24 GPM	24	NS	Call for Pricing
801-5-40W	40" x 2¾" Polyester-Plus™ Filter Media	5µ	24	24 GPM	24	NS	Call for Pricing
801-10-40W	40" x 2¾" Polyester-Plus™ Filter Media	10µ	24	24 GPM	24	NS	Call for Pricing
801-20-40W	40" x 2¾" Polyester-Plus™ Filter Media	20µ	24	24 GPM	24	NS	Call for Pricing
801-50-40W	40" x 2¾" Polyester-Plus™ Filter Media	50µ	24	24 GPM	24	NS	Call for Pricing

Non-Stock Harmsco cartridges can be drop shipped in case quantities.



LEAK DETECTOR

- Reliable Mechanical Operation
- Stops Water Flow
- No Battery Required

ANGLE STOP VALVE

- Reversible Position
- 3/8" Valve Connection
- 1/4" Branch
- 1/2" Adaptors Included

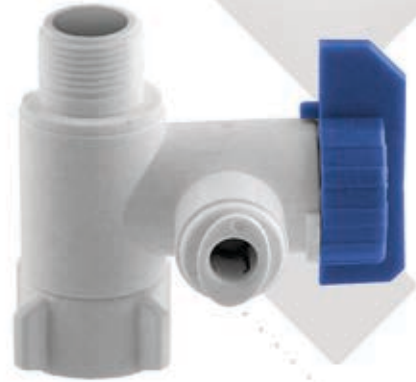

PRESSURE REDUCING VALVES

Ideal for

- Filters
- RO's
- Any POU Installation



Miscellaneous Components



Leak Detector

Part Number	Description	Your Price
AW-LD001	Leak Detector, Reliable Mechanical Operation, No Battery Required, Includes 2 Sponges, 1 Adhesive Strip & 2 Screws	Call for Pricing
AW-RSP	Replacement Sponge for AW-LD-001	Call for Pricing



Reversible Angle Stop Valve with Adaptors

Part Number	Description	Your Price
ASC14-38	3/8" Male Comp x 3/8" Female Comp x 1/4" Branch - 1/2" Adaptors Included	Call for Pricing



Pressure Reducing Valves

Part Number	Description	Fitting Size	Pressure Rating	Your Price
Z-LV-FPV0104-50	50 psi Pressure Reducing Valve, Quick-Connect	1/4"	50 psi	Call for Pricing
Z-LV-FPV0104-60	60 psi Pressure Reducing Valve, Quick-Connect	1/4"	60 psi	Call for Pricing
Z-LV-FPV0104-70	70 psi Pressure Reducing Valve, Quick-Connect	1/4"	70 psi	Call for Pricing
Z-LV-FPV0308-50	50 psi Pressure Reducing Valve, Quick-Connect	3/8"	50 psi	Call for Pricing
Z-LV-FPV0308-60	60 psi Pressure Reducing Valve, Quick-Connect	3/8"	60 psi	Call for Pricing
Z-CLV-1S	Clip for Pressure Reducing Valves	N/A	N/A	Call for Pricing

Call for Pricing on Orders of 500 Units or More.
Valves are available in 40, 50, 60, 70, 80 & 125 psi with 1/4" or 3/8" Quick-Connect Fittings.



Thread Sealing Tape

Part Number	Description	Your Price
500X520TFE	520" x 1/2" Thread Sealing Tape	Call for Pricing



Faucets

Lead-Free Contemporary Style Faucets

Part Number	Description	Case Qty	Case Wgt	Your Price
N-755-BG-LF	¼ Turn Ceramic Disk Valve – Brushed Gold Finish	20	43 lbs.	Call for Pricing
N-755-1-LF	¼ Turn Ceramic Disk Valve – Chrome Finish	20	43 lbs.	Call for Pricing
N-755-BN-LF	¼ Turn Ceramic Disk Valve – Brushed Nickel Finish	20	43 lbs.	Call for Pricing
N-755-MBLK-LF	¼ Turn Ceramic Disk Valve – Matte Black Finish	20	43 lbs.	Call for Pricing
N-755-ORB-LF	¼ Turn Ceramic Disk Valve – Oil Rubbed Bronze Finish	20	43 lbs.	Call for Pricing

N-755-BG-LF
BRUSHED GOLD

N-755-1-LF
CHROME

N-755-BN-LF
BRUSHED NICKEL

N-755-MBLK-LF
MATTE BLACK

N-755-ORB-LF
OIL RUBBED BRONZE



Lead-Free Standard Faucets

Part Number	Description	Case Qty	Case Wgt	Your Price
WDF-103-C-LF-ES85	Standard Long Reach Faucet – Chrome Finish, Chrome Tip (8.5cm Shank)	50	42 lbs.	Call for Pricing
WDF-103-BN-LF-ES85	Standard Long Reach Faucet – Brushed Nickel Finish, Black Tip (8.5cm Shank)	50	42 lbs.	Call for Pricing
WDF-103-BN-LF	Standard Long Reach Faucet – Brushed Nickel Finish, Black Tip	50	42 lbs.	Call for Pricing

Lead-Free Vase Style Faucets

Part Number	Description	Case Qty	Case Wgt	Your Price
N-833-BG-LF	¼ Turn Ceramic Disk Valve – Brushed Gold Finish	20	29 lbs.	Call for Pricing
N-833-1-LF	¼ Turn Ceramic Disk Valve – Chrome Finish	20	29 lbs.	Call for Pricing
N-833-BN-LF	¼ Turn Ceramic Disk Valve – Brushed Nickel Finish	20	29 lbs.	Call for Pricing
N-833-MBLK-LF	¼ Turn Ceramic Disk Valve – Matte Black Finish	20	29 lbs.	Call for Pricing
N-833-ORB-LF	¼ Turn Ceramic Disk Valve – Oil Rubbed Bronze Finish	20	29 lbs.	Call for Pricing

N-833-BG-LF
BRUSHED GOLD

N-833-1-LF
CHROME

N-833-BN-LF
BRUSHED NICKEL

N-833-MBLK-LF
MATTE BLACK

N-833-ORB-LF
OIL RUBBED BRONZE

WDF-103-B-LF
CHROME W/ BLACK TIP

WDF-103-C-LF
CHROME W/ CHROME TIP



**CERAMIC DISK – HIGHER QUALITY
THAN PLASTIC VALVES**

Lead-Free Long Reach Luxury Faucets



Part Number	Description	Case Qty	Case Wgt	Your Price
N-109-BG-LF	¼ Turn Ceramic Disk Valve – Brushed Gold Finish	20	29 lbs.	Call for Pricing
N-109-1-LF	¼ Turn Ceramic Disk Valve – Chrome Finish	20	29 lbs.	Call for Pricing
N-109-BN-LF	¼ Turn Ceramic Disk Valve – Brushed Nickel Finish	20	29 lbs.	Call for Pricing
N-109-WH-LF	¼ Turn Ceramic Disk Valve – White Finish	20	29 lbs.	Call for Pricing
N-109-MWH-LF	¼ Turn Ceramic Disk Valve – Matte White Finish	20	29 lbs.	Call for Pricing
N-109-BLK-LF	¼ Turn Ceramic Disk Valve – Black Finish	20	29 lbs.	Call for Pricing
N-109-MBLK-LF	¼ Turn Ceramic Disk Valve – Matte Black Finish	20	29 lbs.	Call for Pricing
N-109-AL-LF	¼ Turn Ceramic Disk Valve – Almond Finish	20	29 lbs.	Call for Pricing
N-109-PB-LF	¼ Turn Ceramic Disk Valve – Polished Brass Finish	20	29 lbs.	Call for Pricing
N-109-ORB-LF	¼ Turn Ceramic Disk Valve – Oil Rubbed Bronze Finish	20	29 lbs.	Call for Pricing

N-109-BG-LF
BRUSHED GOLD

N-109-1-LF
CHROME

N-109-BN-LF
BRUSHED NICKEL

N-109-WH-LF
WHITE

N-109-BLK-LF
BLACK

N-109-ORB-LF
OIL RUBBED BRONZE



Lead-Free Euro Style Faucets



Part Number	Description	Case Qty	Case Wgt	Your Price
N-109-1-E-LF	¼ Turn Ceramic Disk Valve – Chrome Finish	20	29 lbs.	Call for Pricing
N-109-BN-E-LF	¼ Turn Ceramic Disk Valve – Brushed Nickel Finish	20	29 lbs.	Call for Pricing
N-109-WH-E-LF	¼ Turn Ceramic Disk Valve – White Finish	20	29 lbs.	Call for Pricing
N-109-BLK-E-LF	¼ Turn Ceramic Disk Valve – Black Finish	20	29 lbs.	Call for Pricing
N-109-MBLK-E-LF	¼ Turn Ceramic Disk Valve – Matte Black Finish	20	29 lbs.	Call for Pricing
N-109-AL-E-LF	¼ Turn Ceramic Disk Valve – Almond Finish	20	29 lbs.	Call for Pricing
N-109-PB-E-LF	¼ Turn Ceramic Disk Valve – Polished Brass Finish	20	29 lbs.	Call for Pricing
N-109-ORB-E-LF	¼ Turn Ceramic Disk Valve – Oil Rubbed Bronze Finish	20	29 lbs.	Call for Pricing

N-109-1-E-LF
CHROME

N-109-BN-E-LF
BRUSHED NICKEL

N-109-WH-E-LF
WHITE

N-109-BLK-E-LF
BLACK

N-109-ORB-E-LF
OIL RUBBED BRONZE



Lead-Free Air-Gap Faucets



Part Number	Description	Case Qty	Case Wgt	Your Price
N-109-1-AG-LF	¼ Turn Ceramic Disk Valve – Chrome Finish	20	27 lbs.	Call for Pricing
N-109-BN-AG-LF	¼ Turn Ceramic Disk Valve – Brushed Nickel Finish	20	27 lbs.	Call for Pricing
N-109-WH-AG-LF	¼ Turn Ceramic Disk Valve – White Finish	20	27 lbs.	Call for Pricing
N-109-BLK-AG-LF	¼ Turn Ceramic Disk Valve – Black Finish	20	27 lbs.	Call for Pricing
N-109-MBLK-AG-LF	¼ Turn Ceramic Disk Valve – Matte Black Finish	20	27 lbs.	Call for Pricing
N-109-AL-AG-LF	¼ Turn Ceramic Disk Valve – Almond Finish	20	27 lbs.	Call for Pricing
N-109-ORB-AG-LF	¼ Turn Ceramic Disk Valve – Oil Rubbed Bronze Finish	20	27 lbs.	Call for Pricing



N-109-1-AG-LF
CHROME

N-109-BN-AG-LF
BRUSHED NICKEL

FLR-878CP
CHROME

N-109-BN-E-AG-LF
BRUSHED NICKEL

N-109-ORG-E-AG-LF
OIL RUBBED BRONZE



Lead-Free Air-Gap with Euro Styling Faucets



Part Number	Description	Case Qty	Case Wgt	Your Price
N-109-1-E-AG-LF	¼ Turn Ceramic Disk Valve – Chrome Finish	20	27 lbs.	Call for Pricing
N-109-BN-E-AG-LF	¼ Turn Ceramic Disk Valve – Brushed Nickel Finish	20	27 lbs.	Call for Pricing
N-109-WH-E-AG-LF	¼ Turn Ceramic Disk Valve – White Finish	20	27 lbs.	Call for Pricing
N-109-AL-E-AG-LF	¼ Turn Ceramic Disk Valve – Almond Finish	20	27 lbs.	Call for Pricing
N-109-ORB-E-AG-LF	¼ Turn Ceramic Disk Valve – Oil Rubbed Bronze Finish	20	27 lbs.	Call for Pricing

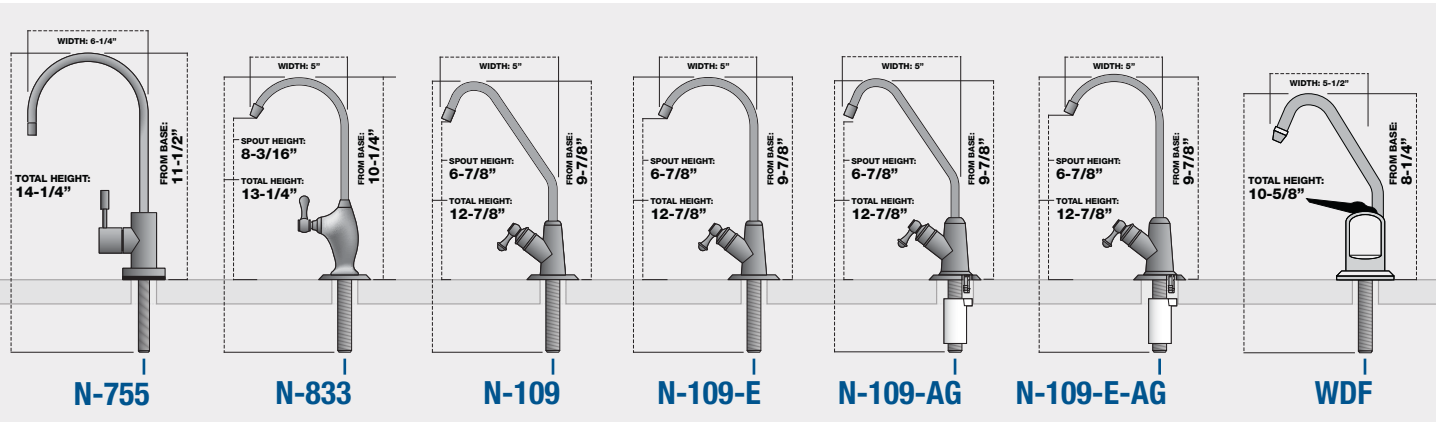

Luxury Faucets with Euro Styling (NSF Certified)



Part Number	Description	Case Qty	Case Wgt	Your Price
FLR-173BN	¼ Turn Composite Disk Valve – Brushed Nickel Finish	20	23 lbs.	Call for Pricing
FLR-878CP	¼ Turn Composite Disk Valve – Chrome Finish	20	31 lbs.	Call for Pricing
FLR-878BN	¼ Turn Composite Disk Valve – Brushed Nickel Finish	20	31 lbs.	Call for Pricing

FLR-575BN
BRUSHED NICKEL

FLR-173BN
BRUSHED NICKEL

FLR-878CP
CHROME

FLR-878BN
BRUSHED NICKEL



Male Connectors (NPTF) – Straight Adaptors



Part Number	Construction Material	Tube Size	Thread Size	Box Qty	Stock	Your Price
PP010821W	White Polypropylene	¼"	¼"	500	S	Call for Pricing
PP010822W	White Polypropylene	¼"	¼"	400	S	Call for Pricing
PP010823W	White Polypropylene	¼"	¾"	400	S	Call for Pricing
PP011222W	White Polypropylene	¾"	¼"	250	S	Call for Pricing
PP011223W	White Polypropylene	¾"	¾"	250	S	Call for Pricing
PP011623W	White Polypropylene	½"	¾"	150	S	Call for Pricing
PI010822S	Grey Acetal	¼"	¼"	400	S	Call for Pricing
PI010823S	Grey Acetal	¼"	¾"	300	S	Call for Pricing
PI011222S	Grey Acetal	¾"	¼"	250	S	Call for Pricing
PI011223S	Grey Acetal	¾"	¾"	250	S	Call for Pricing
PI011224S	Grey Acetal	¾"	½"	200	S	Call for Pricing
PI011624S	Grey Acetal	½"	½"	150	S	Call for Pricing

Union Tees – Equal Tees



Part Number	Construction Material	Tube Size	Box Qty	Stock	Your Price
PP0208W	White Polypropylene	¼"	300	S	Call for Pricing
PP0212W	White Polypropylene	¾"	100	S	Call for Pricing
PP0216W	White Polypropylene	½"	80	S	Call for Pricing
PI0208S	Grey Acetal	¼"	300	S	Call for Pricing
PI0212S	Grey Acetal	¾"	100	S	Call for Pricing
PI0216S	Grey Acetal	½"	50	S	Call for Pricing

Reducing Branch Tee – Reducing Tee



Part Number	Construction Material	Run Size	Branch Size	Box Qty	Stock	Your Price
PP30121208W	White Polypropylene	¾" x ¾"	¼"	150	S	Call for Pricing
PI301208S	Grey Acetal	¾" x ¾"	¼"	150	S	Call for Pricing
PI301612S	Grey Acetal	½" x ½"	¾"	50	S	Call for Pricing

Union Connectors – Equal Straight Connectors



Part Number	Construction Material	Tube Size	Box Qty	Stock	Your Price
PP0408W	White Polypropylene	¼"	400	S	Call for Pricing
PP0412W	White Polypropylene	¾"	200	S	Call for Pricing
PI0408S	Grey Acetal	¼"	400	S	Call for Pricing
PI0412S	Grey Acetal	¾"	200	S	Call for Pricing
PI0416S	Grey Acetal	½"	100	S	Call for Pricing

Union Elbows – Equal Elbow Connectors



Part Number	Construction Material	Tube Size	Box Qty	Stock	Your Price
PP0308W	White Polypropylene	¼"	400	S	Call for Pricing
PP0312W	White Polypropylene	¾"	200	S	Call for Pricing
PI0308S	Grey Acetal	¼"	400	S	Call for Pricing
PI0312S	Grey Acetal	¾"	200	S	Call for Pricing
PI0316S	Grey Acetal	½"	100	S	Call for Pricing

Fixed Elbows (NPTF) – Rigid Elbow Adaptors



Part Number	Construction Material	Tube Size	Thread Size	Box Qty	Stock	Your Price
PP480821W	White Polypropylene	¼"	¼"	500	S	Call for Pricing
PP480822W	White Polypropylene	¼"	¼"	400	S	Call for Pricing
PP480823W	White Polypropylene	¼"	¾"	300	S	Call for Pricing
PP481222W	White Polypropylene	¾"	¼"	200	S	Call for Pricing
PP481223W	White Polypropylene	¾"	¾"	200	S	Call for Pricing
PI480821S	Grey Acetal	¼"	¼"	500	S	Call for Pricing
PI480822S	Grey Acetal	¼"	¼"	400	S	Call for Pricing
PI480823S	Grey Acetal	¼"	¾"	300	S	Call for Pricing
PI481222S	Grey Acetal	¾"	¼"	200	S	Call for Pricing
PI481223S	Grey Acetal	¾"	¾"	200	S	Call for Pricing

Plug In Elbows - Stem Elbows



Part Number	Construction Material	Tube Size	Stem Size	Box Qty	Stock	Your Price
PP220808W	White Polypropylene	¼"	¼"	500	S	Call for Pricing
PP221208W	White Polypropylene	¼"	¾"	300	S	Call for Pricing
PP221212W	White Polypropylene	¾"	¾"	200	S	Call for Pricing
PP221616W	White Polypropylene	½"	½"	150	S	Call for Pricing
PI220808S	Grey Acetal	¼"	¼"	500	S	Call for Pricing

Bulkhead Unions – Bulkhead Connectors



Part Number	Construction Material	Tube Size	Thread Size	Box Qty	Stock	Your Price
PP1208W	White Polypropylene	¼"	¼"	200	NS	Call for Pricing
PP1212W	White Polypropylene	¾"	¾"	100	S	Call for Pricing
PI1208S	Grey Acetal	¼"	¼"	200	S	Call for Pricing
PI1212S	Grey Acetal	¾"	¾"	100	S	Call for Pricing





Locking Clips

Part Number	Construction Material	Thread Size	Box Qty	Stock	Your Price
PIC1808R	Red Acetal	¼"	5,000	S	Call for Pricing
PIC1812R	Red Acetal	¾"	1,000	S	Call for Pricing
PIC1816R	Red Acetal	½"	1,200	S	Call for Pricing



Stem Adaptors (NPTF)

Part Number	Construction Material	Stem Size	Thread Size	Box Qty	Stock	Your Price
PP050822W	White Polypropylene	¼"	¼"	500	NS	Call for Pricing
PP051222W	White Polypropylene	¾"	¼"	300	S	Call for Pricing
PP051223W	White Polypropylene	¾"	¾"	200	S	Call for Pricing
PI051222S	Grey Acetal	¾"	¼"	300	S	Call for Pricing
PI050822S	Grey Acetal	¼"	¼"	500	S	Call for Pricing



Reducers

Part Number	Construction Material	Tube Size	Thread Size	Box Qty	Stock	Your Price
PP061208W	White Polypropylene	¼"	¾"	400	S	Call for Pricing



Plugs

Part Number	Construction Material	Stem Size	Box Qty	Stock	Your Price
PI0808S	Grey Acetal	¼"	500	S	Call for Pricing
PI0812S	Grey Acetal	¾"	400	S	Call for Pricing
PI0816S	Grey Acetal	½"	300	S	Call for Pricing

PI4712S

PI211208S

PI250808S

PP450822W

NC2258

NC2098LF

FRC-0.5GPM-PI010823S



Equal Cross Connector, Reducing Elbow, Tube to Hose Stem & Female Connector

Part Number	Construction Material	Stem Size	Thread Size	Box Qty	Stock	Your Price
PI4712S	¾" Equal Cross Connector (Grey Acetal)	¾" (4)	N/A	100	S	Call for Pricing
PI211208S	¾" x ¼" Reducing Elbow (Grey Acetal)	¾"	¼"	200	S	Call for Pricing
PI250808S	¼" x ¼" Tube to Hose Stem (Grey Acetal)	¼"	¼"	500	S	Call for Pricing
PP450822W	¼" x ¼" Female Adaptor (Polypropylene)	¼"	¼"	200	S	Call for Pricing
NC2258	Brass ¾" Garden Hose x ¾" Tube Female Adaptor	¾"	¾"	100	S	Call for Pricing
NC2098LF	Brass ¾" Garden Hose x ¼" Tube Female Adaptor	¼"	¾"	100	S	Call for Pricing
FRC-0.5GPM-PI010823S	PI010823S w/ 0.5 GPM Stainless Steel Flow Restrictor*	¼" JG	¾" MPT	N/A	S	Call for Pricing
FRC-1GPM-PI010823S	PI010823S w/ 1 GPM Stainless Steel Flow Restrictor*	¼" JG	¾" MPT	N/A	S	Call for Pricing

*Many male connectors and fixed elbow fittings are available with built-in, stainless steel flow restrictors in minimum quantities of 50 units.



Reducing Unions – Reducing Straight Connectors

Part Number	Construction Material	Tube Size 1	Tube Size 2	Box Qty	Stock	Your Price
PP201208W	White Polypropylene	¾"	¼"	200	S	Call for Pricing
PI201208S	Grey Acetal	¾"	¼"	200	S	Call for Pricing
PI201210S	Grey Acetal	¾"	5/16"	200	S	Call for Pricing
PI201612S	Grey Acetal	¾"	½"	100	S	Call for Pricing



Faucet Connectors (UNS)

Part Number	Construction Material	Tube Size	Thread Size	Box Qty	Stock	Your Price
PP3208U7W-US	¼" x 7/16" UNS Faucet Connector	¼"	7/16"	400	S	Call for Pricing
PP3212U7W	¾" x 7/16" UNS Faucet Connector	¾"	7/16"	400	S	Call for Pricing
CI3208U7S	Grey Acetal	¼"	7/16"	250	S	Call for Pricing
CI3212U7S	Grey Acetal	¾"	7/16"	200	S	Call for Pricing



End Stops

Part Number	Construction Material	Tube Size	Box Qty	Stock	Your Price
PI4608S	Grey Acetal	¼"	500	S	Call for Pricing
PI4612S	Grey Acetal	¾"	500	S	Call for Pricing

Speedfit to Speedfit Connectors

Part Number	Description	Box Qty	Stock	Your Price
PPSV040803W	¼" JG® – ¼" JG® Straight Valve (Polypropylene)	200	S	Call for Pricing
PPSV041212W	¾" JG® – ¾" JG® Straight Valve (Polypropylene)	100	S	Call for Pricing
PISV0416S	½" JG® – ½" JG® Straight Valve (Grey Acetal)	50	S	Call for Pricing

Speedfit to Male NPTF Connectors

Part Number	Description	Box Qty	Stock	Your Price
PPSV010822W	¼" JG® x ¼" Male NPTF Straight Valve (Polypropylene)	200	S	Call for Pricing
PPSV011223W	¾" JG® x ¾" Male NPTF Straight Valve (Polypropylene)	100	S	Call for Pricing

Speedfit to Female NPTF Connectors / RO Tank Valve

Part Number	Description	Box Qty	Stock	Your Price
PPSV500822W	¼" JG® x ¼" Female NPTF Elbow Valve (Polypropylene)	200	S	Call for Pricing
PPSV501222W	¾" JG® x ¾" Female NPTF Elbow Valve (Polypropylene)	100	S	Call for Pricing

Check Valves

Part Number	Description	Box Qty	Stock	Your Price
1/4SCV	¼" Single Check Valve (Polypropylene)	300	S	Call for Pricing
3/8SCV	¾" Single Check Valve (Polypropylene)	80	S	Call for Pricing

Angle Stop Adaptor Valves

Part Number	Description	Box Qty	Stock	Your Price
PASVPP1	¾" Male Compression x ¾" Female Compression x ¼" (Polypropylene)	25	S	Call for Pricing
PASVPP2	¾" Male Compression x ¾" Female Compression x ¾" (Polypropylene)	25	S	Call for Pricing
ASVPP1LF	¾" Male Compression x ¾" Female Comp x ¼" JG® – Lead Free	30	S	Call for Pricing
ASVPP2LF	¾" Male Compression x ¾" Female Comp x ¾" JG® – Lead Free	30	S	Call for Pricing
ASVPP5LF	½" Male Compression x ¾" Female Comp x ½"/¼" JG® – Lead Free	30	S	Call for Pricing
ASVPP6LF	½" Male Compression x ¾" Female Comp x ½"/¾" JG® – Lead Free	20	S	Call for Pricing

Polyethylene Tubing

Part Number	Former Part Number	Description	Box Wgt	Box Qty	Stock	Your Price
PE-08-BI-DF-E	PE-08-BI-0500F-E	¼" Tube – 500 ft Roll (Black)	15 lbs.	2	S	Call for Pricing
PE-08-BI-DF-B	PE-08-BI-0500F-B	¼" Tube – 500 ft Roll (Blue)	15 lbs.	2	S	Call for Pricing
PE-08-BI-DF-W	PE-08-BI-0500F-W	¼" Tube – 500 ft Roll (White)	15 lbs.	2	S	Call for Pricing
PE-08-BI-DF-R	PE-08-BI-0500F-R	¼" Tube – 500 ft Roll (Red)	15 lbs.	2	S	Call for Pricing
PE-08-BI-DF-G	PE-08-BI-0500F-G	¼" Tube – 500 ft Roll (Green)	15 lbs.	2	S	Call for Pricing
PE-12-EI-DF-E	PE-12-EI-0500F-E	¾" Tube – 500 ft Roll (Black)	15 lbs.	1	S	Call for Pricing
PE-12-EI-DF-B	PE-12-EI-0500F-B	¾" Tube – 500 ft Roll (Blue)	15 lbs.	1	S	Call for Pricing
PE-12-EI-DF-W	PE-12-EI-0500F-W	¾" Tube – 500 ft Roll (White)	15 lbs.	1	S	Call for Pricing
PE-16-GI-CCLF-E	PE-16-GI-0250F-E	½" Tube – 250 ft Roll (Black)	12 lbs.	1	S	Call for Pricing
PE-16-GI-CCLF-B	PE-16-GI-0250F-B	½" Tube – 250 ft Roll (Blue)	12 lbs.	1	S	Call for Pricing
PE-16-GI-CCLF-W	PE-16-GI-0250F-W	½" Tube – 250 ft Roll (White)	12 lbs.	1	S	Call for Pricing

100' Rolls of Tubing

Part Number	Description	Stock	Your Price
PE-08-BI-0100F-E	¼" Tube – 100 ft (Black)	S	Call for Pricing
PE-08-BI-0100F-B	¼" Tube – 100 ft (Blue)	S	Call for Pricing
PE-08-BI-0100F-W	¼" Tube – 100 ft (White)	S	Call for Pricing
PE-12-EI-0100F-E	¾" Tube – 100 ft (Black)	S	Call for Pricing
PE-12-EI-0100F-B	¾" Tube – 100 ft (Blue)	S	Call for Pricing
PE-12-EI-0100F-W	¾" Tube – 100 ft (White)	S	Call for Pricing





Collet Locking Tool

Part Number	Description	Stock	Your Price
TSPITool	1/4" – 3/8" Release Tool	S	Call for Pricing



Tube Cutters & Replacement Blades

Part Number	Description	Stock	Your Price
TSNIP	Tube Cutter	S	Call for Pricing
BLADES	Tube Cutter Replacement Blades	S	Call for Pricing



Part Number	Description	Bag	Box Qty	Stock	Your Price
PSEI012826E	Male Connector, 3/4" CTS x 3/4" NPT (Black)	5	50	S	Call for Pricing
PSEI012828E	Male Connector, 3/4" CTS x 1" NPT (Black)	5	30	S	Call for Pricing
PSEI013628E	Male Connector, 1" CTS x 1" NPT (Black)	2	20	S	Call for Pricing
PSEI452826	Female Connector, 3/4" CTS x 3/4" Brass NPT (White)	5	40	S	Call for Pricing
PSEISV28P	3/4" CTS x 3/4" CTS Shut-off Valve (White)	1	75	S	Call for Pricing
PEI0228E	PEX Union Tee, 3/4" CTS (Black)	2	10	S	Call for Pricing
PEI0236	PEX Union Tee, 1" CTS (White)	1	5	S	Call for Pricing
PEI3036A	PEX Reducing Tee 1" x 1" x 3/4"	1	10	S	Call for Pricing
PEI0328E	PEX Union Elbow, 3/4" CTS (Black)	5	20	S	Call for Pricing
PEI0336E	PEX Union Elbow, 1" CTS (Black)	1	10	S	Call for Pricing
PEI0428E	PEX Coupler, 3/4" CTS (Black)	5	25	S	Call for Pricing
PEI0436E	PEX Coupler, 1" CTS (Black)	1	15	S	Call for Pricing
PSEI203628E	PEX Reducing Union 1" x 3/4" (Black)		20	S	Call for Pricing
PEI062820	PEX Reducer, 3/4" Stem – 1/2" Pipe (White)	10	50	S	Call for Pricing
PEI063628	PEX Reducer, 1" Stem – 3/4" Pipe (White)	5	30	S	Call for Pricing

Male Connector

Female Connector

Shut-Off Valve

Union Tee

Union Elbow



Coupler

Reducing tee

Reducer

Reducing Union

Reducing Elbow





SharkBite®
FITTINGS, PEX PIPE & CONNECTORS

THE TOTAL PLUMBING SOLUTION

SharkBite is a provider of popular Quick-Connect Brass Fittings as well as SharkBite PEX Piping and Connectors.

WHY SHARKBITE?

Spend any amount of time working with plumbing fittings and you'll see why SharkBite is the most trusted name in the industry.

QUALITY

Compatible with Copper, CPVC, PEX, PE-RT & HDPE pipes. No matter what you're connecting, SharkBite has you covered. Solutions also available for transitioning from PVC and Polybutylene pipe.

LEAD FREE

The Reduction of Lead Safe Water Drinking Act went into effect January 2014. Since October 2012, SharkBite has been shipping all Lead Free products in anticipation of the Act.

WARRANTY

You take your job seriously and follow the local, state and federal requirements to a tee. When installing SharkBite products you follow all the plumbing, heating and mechanical codes as well as SharkBite's guidelines. You should be rewarded for that. That's why SharkBite offers a warranty of 25 years.



SharkBite® Fittings



Straight Couplers

Part Number	Description	Bag Qty	Stock	Your Price
U008LF	1/2" x 1/2" Coupling, Lead Free Brass	12	S	Call for Pricing
U016LF	3/4" x 3/4" Coupling, Lead Free Brass	12	S	Call for Pricing
U020LF	1" x 1" Coupling, Lead Free Brass	6	S	Call for Pricing



Reducing Couplers

Part Number	Description	Bag Qty	Stock	Your Price
U050LF	1/4" x 1/2" Reducing Coupling, Lead Free Brass	6	S	Call for Pricing
U058LF	3/4" x 1/2" Reducing Coupling, Lead Free Brass	12	S	Call for Pricing
U060LF	1" x 3/4" Reducing Coupling, Lead Free Brass	6	S	Call for Pricing



Female Connectors

Part Number	Description	Bag Qty	Stock	Your Price
U068LF	1/2" x 3/4" FNPT Reducing Female Connector, Lead Free Brass	6	S	Call for Pricing
U088LF	3/4" x 3/4" FNPT Straight Female Connector, Lead Free Brass	6	S	Call for Pricing
U094LF	1" x 1" FNPT Straight Female Connector, Lead Free Brass	6	S	Call for Pricing

Male Connectors



Part Number	Description	Bag Qty	Stock	Your Price
U116LF	1/2" x 3/4" MNPT Reducing Male Connector, Lead Free Brass	6	S	Call for Pricing
U120LF	1/2" x 1/2" MNPT Straight Male Connector, Lead Free Brass	12	S	Call for Pricing
U134LF	3/4" x 3/4" MNPT Straight Male Connector, Lead Free Brass	12	S	Call for Pricing
U139LF	3/4" x 1" Reducing Coupling, Lead Free Brass	6	S	Call for Pricing
U140LF	1" x 1" MNPT Straight Male Connector, Lead Free Brass	6	S	Call for Pricing
U3523LF	1/4" (9/16" OD) x 3/8" Comp. Stop Valve Conn., Lead Free Brass, Converts 3/8" Comp. Stop to SharkBite	6	S	Call for Pricing
U3524LF	1/4" (9/16" OD) x 1/4" Compression Nut, Lead Free Brass	6	S	Call for Pricing



Male Slip Connectors

Part Number	Description	Bag Qty	Stock	Your Price
U3134LF	3/4" x 3/4" MNPT Slip Male Connector, Lead Free Brass	6	S	Call for Pricing
U3140LF	1" x 1" MNPT Slip Male Connector, Lead Free Brass	6	S	Call for Pricing



90° Elbows

Part Number	Description	Bag Qty	Stock	Your Price
U248LF	1/2" x 1/2" Elbow, Lead Free Brass	12	S	Call for Pricing
U256LF	3/4" x 3/4" Elbow, Lead Free Brass	6	S	Call for Pricing
U260LF	1" x 1" Elbow, Lead Free Brass	6	S	Call for Pricing



Tees

Part Number	Description	Bag Qty	Stock	Your Price
U362LF	1/2" x 1/2" x 1/2" Tee, Lead Free Brass	12	S	Call for Pricing
U370LF	3/4" x 3/4" x 3/4" Tee, Lead Free Brass	6	S	Call for Pricing
U374LF	1" x 1" x 1" Tee, Lead Free Brass	3	S	Call for Pricing
U412LF	3/4" x 3/4" x 1/2" Reducing Tee, Lead Free Brass	6	S	Call for Pricing



Slip Tees

Part Number	Description	Bag Qty	Stock	Your Price
U3362LF	1/2" x 1/2" x 1/2" Slip Tee, Lead Free Brass	3	S	Call for Pricing
U3370LF	3/4" x 3/4" x 3/4" Slip Tee, Lead Free Brass	3	S	Call for Pricing



End Caps

Part Number	Description	Bag Qty	Stock	Your Price
U514LF	1/2" End Cap, Lead Free Brass	12	S	Call for Pricing
U518LF	3/4" End Cap, Lead Free Brass	6	S	Call for Pricing
U520LF	1" End Cap, Lead Free Brass	6	S	Call for Pricing



Disconnect Clips

Part Number	Description	Bag Qty	Stock	Your Price
U710	1/2" Disconnect Clips	24	S	Call for Pricing
U712	3/4" Disconnect Clips	24	S	Call for Pricing
U714	1" Disconnect Clips	12	S	Call for Pricing

PEX Couplers



Part Number	Description	Bag Qty	Stock	Your Price
UC008LF	1/2" x 1/2" PEX Coupling, Lead Free Brass	25	S	Call for Pricing
UC016LF	3/4" x 3/4" PEX Coupling, Lead Free Brass	25	S	Call for Pricing
UP016	3/4" x 3/4" Coupling, Acudel Polymer	25	S	Call for Pricing
UC020LF	1" x 1" PEX Coupling, Lead Free Brass	10	S	Call for Pricing
UP020	1" x 1" Coupling, Acudel Polymer	25	S	Call for Pricing

PEX Reducing Couplers



Part Number	Description	Bag Qty	Stock	Your Price
UC058LF	1/2" x 3/4" Reducing Coupling, Lead Free Brass	25	S	Call for Pricing
UC060LF	3/4" x 1" Reducing Coupling, Lead Free Brass	25	S	Call for Pricing
UP060	3/4" x 1" Reducing Coupling, Acudel Polymer	25	S	Call for Pricing

PEX Female Adaptors



Part Number	Description	Bag Qty	Stock	Your Price
UC072LF	1/2" x 1/2" FNPT Threaded Female Adaptor, Lead Free Brass	25	S	Call for Pricing
UC088LF	3/4" x 3/4" FNPT Threaded Female Adaptor, Lead Free Brass	25	S	Call for Pricing
UC094LF	1" x 1" FNPT Threaded Female Adaptor, Lead Free Brass	10	S	Call for Pricing

PEX Male Adaptors



Part Number	Description	Bag Qty	Stock	Your Price
UC116LF	1/2" x 3/4" MNPT Threaded Male Adaptor, Lead Free Brass	25	S	Call for Pricing
UC120LF	1/2" x 1/2" MNPT Threaded Male Adaptor, Lead Free Brass	25	S	Call for Pricing
UC134LF	3/4" x 3/4" MNPT Threaded Male Adaptor, Lead Free Brass	25	S	Call for Pricing
UP134	3/4" x 3/4" MNPT Threaded Male Adaptor, Acudel Polymer	25	S	Call for Pricing
UC140LF	1" x 1" MNPT Threaded Male Adaptor, Lead Free Brass	10	S	Call for Pricing
UP140	1" x 1" MNPT Straight Male Connector, Acudel Polymer	25	S	Call for Pricing

PEX 90° Elbows



Part Number	Description	Bag Qty	Stock	Your Price
UC248LF	1/2" x 1/2" Elbow, Lead Free Brass	25	S	Call for Pricing
UC256LF	3/4" x 3/4" Elbow, Lead Free Brass	25	S	Call for Pricing
UP256	3/4" x 3/4" Elbow, Acudel Polymer	25	S	Call for Pricing
UC260LF	1" x 1" Elbow, Lead Free Brass	10	S	Call for Pricing
UP260	1" x 1" Elbow, Acudel Polymer	25	S	Call for Pricing

PEX Tees



Part Number	Description	Bag Qty	Stock	Your Price
UC362LF	1/2" x 1/2" x 1/2" Tee, Lead Free Brass	25	S	Call for Pricing
UC370LF	3/4" x 3/4" x 3/4" Tee, Lead Free Brass	25	S	Call for Pricing
UP370	3/4" x 3/4" x 3/4" Tee, Acudel Polymer	25	S	Call for Pricing
UC374LF	1" x 1" x 1" Tee, Lead Free Brass	10	S	Call for Pricing
UP374	1" x 1" x 1" Tee, Acudel Polymer	25	S	Call for Pricing
UC412LF	3/4" x 1/2" x 3/4" Reducing Tee, Lead Free Brass	25	S	Call for Pricing
UP416	1" x 1" x 3/4" Reducing Tee, Acudel Polymer	25	NS	Call for Pricing

PEX Barb Ball Valves



Part Number	Description	Bag Qty	Stock	Your Price
22462LF	3/4" Barb Valve, Lead Free Brass	12	S	Call for Pricing
22463LF	1" Barb Valve, Lead Free Brass	6	S	Call for Pricing

PEX Clamp & Crimp Rings



Part Number	Description	Bag Qty	Stock	Your Price
UC953	1/2" Stainless Steel PEX Clamp Ring	100	S	Call for Pricing
UC955	3/4" Stainless Steel PEX Clamp Ring	100	S	Call for Pricing
UC956	1" Stainless Steel PEX Clamp Ring	50	S	Call for Pricing
23102	1/2" Copper PEX Crimp Ring	100	S	Call for Pricing
23103	3/4" Copper PEX Crimp Ring	100	S	Call for Pricing
23104	1" Copper PEX Crimp Ring	25	S	Call for Pricing
23221	3/4" J Hook PEX Pipe Clamp	10	S	Call for Pricing

PEX Pipes

Part Number	Description	Stock	Your Price
U860W10	1/2" - 10 ft Pex Pipe - White	S	Call for Pricing
U870W10	3/4" - 10 ft Pex Pipe - White	S	Call for Pricing
U870B10	3/4" - 10 ft Pex Pipe - Blue	S	Call for Pricing
U870R10	3/4" - 10 ft Pex Pipe - Red	NS	Call for Pricing
U880W10	1" - 10 ft Pex Pipe - White	S	Call for Pricing
U880B10	1" - 10 ft Pex Pipe - Blue	S	Call for Pricing
U880R10	1" - 10 ft Pex Pipe - Red	NS	Call for Pricing

PEX Coiled Tubing

Part Number	Description	Stock	Your Price
U850W100	1/4" ID / 3/8" OD - 100 ft Roll Pex Pipe (White)	S	Call for Pricing
U855W100	3/8" ID / 1/2" OD - 100 ft Roll Pex Pipe (White)	S	Call for Pricing





Valves

Part Number	Description	Bag Qty	Stock	Your Price
22185-0000LF	3/4" x 3/4" Ball Valve	12	S	Call for Pricing
22223-0000LF	1" x 1" Ball Valve	6	S	Call for Pricing
U2016-0000LF	3/4" x 3/4" Check Valve, Lead Free Brass	6	S	Call for Pricing
23036-0000LF	1/2" QC x 3/8" Compression Angle Stop, Lead Free Brass	12	S	Call for Pricing

PVC Adaptors and Fixed Elbows

Part Number	Description	Bag Qty	Stock	Your Price
U286LF	3/4" SharkBite x 3/4" MPT Male Elbow	6	S	Call for Pricing
UIP4016	3/4" SharkBite x 3/4" PVC Transition Coupler	6	S	Call for Pricing
UIP4020	1" SharkBite x 1" PVC Transition Coupler	6	S	Call for Pricing
UC286LF	3/4" PEX x 3/4" MPT Male Elbow	25	S	Call for Pricing



U286LF



UIP4016



UIP4020



UC286LF

22632LF
WATER HAMMER ARRESTOR



U702
DEBURR/GAUGE TOOL



25561 & 25562
WATER FILTER INSTALLATION KIT



23251
COMBO CRIMP TOOL



23100
PEX COMBO CRIMP TOOL KIT



UC961
PEX CLAMP TOOL ONE-HAND



Tools, Kits & Arrestors

Part Number	Description	Stock	Your Price
22632LF	3/4" Residential Water Hammer Arrestor	S	Call for Pricing
U702	Deburr/Gauge Tool	S	Call for Pricing
23251	1/2", 3/4" PEX Combo Crimp Tool	S	Call for Pricing
23100	PEX Crimp Ring Tool Kit	S	Call for Pricing
UC961	PEX Clamp Tool One-hand Operation	S	Call for Pricing
25561	3/4" Water Filter Installation Kit	S	Call for Pricing
25562	1" Water Filter Installation Kit	S	Call for Pricing

Water Heater Connectors

Part Number	Description	Case Qty	Stock	Your Price
SS3088FLEX18LF	3/4" SharkBite x 3/4" FIP - 18" SS Corrugated Water Heater Connector	12	S	Call for Pricing
SS3088FLEX24LF	3/4" SharkBite x 3/4" FIP - 24" SS Corrugated Water Heater Connector	12	S	Call for Pricing
SS3094FLEX24LF	1" SharkBite x 1" FIP - 24" SS Corrugated Water Heater Connector	12	S	Call for Pricing
U3088FLEX18LF	3/4" SharkBite x 3/4" FIP - 18" SS Braided Water Heater Connector	12	S	Call for Pricing
U3088FLEX24LF	3/4" SharkBite x 3/4" FIP - 24" SS Braided Water Heater Connector	12	S	Call for Pricing

PEX PIPES



100' ROLL PEX TUBING



CORRUGATED WATER HEATER CONNECTORS



BRAIDED WATER HEATER CONNECTORS





Union Tees

Part Number	Description	Tube Size	Bag Qty	Your Price
WA-UT0404	¼" QC x ¼" QC x ¼" QC Polypropylene Tee	¼" x ¼" x ¼"	100	Call for Pricing



Union Elbows

Part Number	Description	Tube Size	Bag Qty	Your Price
WA-UE0404	¼" QC x ¼" QC Polypropylene Elbow	¼"	100	Call for Pricing
WA-UE0606	¾" QC x ¾" QC Polypropylene Elbow	¾"	100	Call for Pricing



Stem Fittings

Part Number	Description	Stem Size	Thread Size	Bag Qty	Your Price
WA-SA0604	¼" MPT x ¾" QC Polypropylene Stem	¼" MPT	¾" QC	100	Call for Pricing



Faucet Adaptors

Part Number	Description	Tube Size	Thread Size	Bag Qty	Your Price
WA-FA04-716	¼" QC x 7/16" Polypropylene Faucet Adaptor	¼"	7/16"	100	Call for Pricing
WA-FA06-716	¾" QC x 7/16" Polypropylene Faucet Adaptor	¾"	7/16"	100	Call for Pricing



Stoppers

Part Number	Description	Tube Size	Bag Qty	Your Price
WA-PP00BU-4	¼" Rubber Stopper	¼"	100	Call for Pricing
WA-PP00BU-6	¾" Rubber Stopper	¾"	100	Call for Pricing



Plugs

Part Number	Description	Tube Size	Bag Qty	Your Price
WA-AP004G	¼" Polypropylene Plug	¼"	100	Call for Pricing



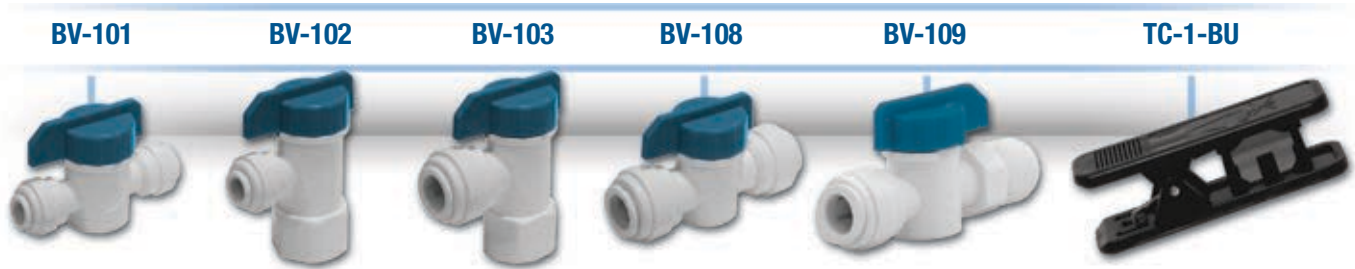

Ball Valves & Tubing

Ball Valves, RO Tank Valves & Tube Cutter

Part Number	Description	Case Qty	Your Price
BV-101	1/4" x 1/4" Quick-Connect Straight Valve	100	Call for Pricing
BV-102	1/4" Quick-Connect x 1/4" Female Elbow Valve – RO Tank Valve	100	Call for Pricing
BV-103	3/8" Quick-Connect x 1/4" Female Elbow Valve – RO Tank Valve	100	Call for Pricing
BV-108	3/8" x 3/8" Quick-Connect Straight Valve	100	Call for Pricing
BV-109	3/8" Quick-Connect x 3/8" MPT Straight Valve	100	Call for Pricing
TC-1-BU	CCK Tube Cutter	100	Call for Pricing

Reverse Osmosis Components

Membrane Housings



Part Number	Description	Case Qty	Case Wgt	Your Price
HM-251	1/4" FNPT Ports, Inlet Port Center of Cap, Smooth	35	37 lbs.	Call for Pricing
HM-QC	1/4" Built-in Quick-Connect, Inlet Port Center of Cap, Smooth	35	30 lbs.	Call for Pricing

Automatic Shutoff Valves



Part Number	Description	Case Qty	Your Price
ASV-QC	Automatic Shut-off with Quick-Connect Fittings	100	Call for Pricing
ASV-TF	Automatic Shut-Off with Jaco® Style Fittings	100	Call for Pricing

Nipples



Part Number	Description	Color	Your Price
Z-PN-4-R	1/4" MPT x 1/4" MPT Nipple with O-Rings	White	Call for Pricing
Z-PN-6-R	3/8" MPT x 3/8" MPT Nipple with O-Rings	White	Call for Pricing
Z-PN-8-R	1/2" MPT x 1/2" MPT Nipple with O-Rings	White	Call for Pricing
Z-PN-12-R	3/4" MPT x 3/4" MPT Nipple with O-Rings	Black	Call for Pricing
Z-PN-16-R	1" MPT x 1" MPT Nipple with O-Rings	Black	Call for Pricing

See Page 64 for Stainless Steel Connectors and 3/4" Stainless Steel Nipples.

RO Tank Valves w Jaco® Style Fitting



Part Number	Description	Your Price
RBV-14	1/4" RO Tank Valve w/ Jaco® style fitting	Call for Pricing

Also see John Guest® RO Tank Valves on Page 39.

Drain Clamps

Part Number	Description	Your Price
DC-14EZ-WH	Drain Clamp with 1/4" Quick-Connect – White	Call for Pricing
DC-38EZ-BLK	Drain Clamp with 3/8" Quick-Connect – Black	Call for Pricing
WP164020	Drain Line Adaptor Kit for Disposal, 3/8" Tube Size	Call for Pricing

DC-14EZ-WH & DC-38EZ-BLK



WP164020



RO-122-W
2.2 GALLON

RO-132-W
3.2 GALLON

RO-152-W
4 GALLON

RO-1070-1/4-WH
14 GALLON

RO-2000-AL
20 GALLON



PA-E Small Bladder Tanks, NSF Certified

Part Number	Description	Capacity @ 60 psi	Ship Wgt	Your Price
RO-122-W	2.2 Gallon Metal Bladder Tank – White	2.17 gal.	6 lbs.	Call for Pricing
RO-132-W	3.2 Gallon Metal Bladder Tank – White	3.17 gal.	9 lbs.	Call for Pricing
RO-132-BL	3.2 Gallon Metal Bladder Tank – Blue	3.17 gal.	9 lbs.	Call for Pricing
RO-152-W	4 Gallon Metal Bladder Tank – White	3.88 gal.	11 lbs.	Call for Pricing

PA-E Large Bladder Tanks, NSF Certified

Part Number	Description	Dimensions (Height x Diameter)	Capacity @ 60 psi	Ship Wgt	Your Price
RO-1070-1/4-WH	14 Gallon Metal Bladder Tank – White	23" x 15.35"	9.79 gal.	27 lbs.	Call for Pricing
RO-2000-AL	20 Gallon Metal Bladder Tank – Almond	30" x 15.35"	14.1 gal.	36 lbs.	Call for Pricing

Check Valves

Part Number	Description	Your Price
CV-02-2SS-EZ	Fixed Elbow Check Valve 1/8" MPT x 1/4" Quick-Connect, White	Call for Pricing
CV-02-4SS-EZ	Fixed Elbow Check Valve 1/4" MPT x 1/4" Quick-Connect, White	Call for Pricing
CV-03-P-J	Fixed Elbow Check Valve 1/8" MPT x 1/4" Jaco® style, White	Call for Pricing
CV-10	Push-in Elbow Check Valve 1/4" Stem x 1/4" Quick-Connect, White	Call for Pricing

Also see John Guest® Check Valves on Page 39.

CV-02-2SS-EZ

CV-03-P-J

CV-10



Flow Restrictors



Part Number	Description	Case Qty	Your Price
FLOW150	Flow Restrictor for 15 GPD RO – Quick-Connect	20	Call for Pricing
FLOW220	Flow Restrictor for 24 GPD RO – Quick-Connect	20	Call for Pricing
FLOW300	Flow Restrictor for 36 GPD RO – Quick-Connect	20	Call for Pricing
FLOW420	Flow Restrictor for 50 GPD RO – Quick-Connect	20	Call for Pricing
FLOW550	Flow Restrictor for 60 GPD RO – Quick-Connect	20	Call for Pricing
FLOW800	Flow Restrictor for 100 GPD RO – Quick-Connect	20	Call for Pricing

Fixed Elbow Flow Restrictors



Part Number	Description	Your Price
FR-2001-EZ-B	1/8" MPT x 1/4" QC Flow Restrictor for 24 GPD RO – Blue insert	Call for Pricing
FR-3001-EZ-G	1/8" MPT x 1/4" QC Flow Restrictor for 36 GPD RO – Green insert	Call for Pricing

Clips



Part Number	Description	Your Price
C-2000W	2" Single Clip – White	Call for Pricing
C-2500W	2 1/2" Single RO Clip – White	Call for Pricing
C-2500B	2 1/2" Single RO Clip – Black	Call for Pricing
DC-2520W	2 1/2" x 2" Double RO Clip – White	Call for Pricing
DC-2520B	2 1/2" x 2" Double RO Clip – Black	Call for Pricing
DC-2020W	2" x 2" Double RO Clip – White	Call for Pricing
DC-3000W	2 1/2" x 2 1/2" Double RO Clip – White	Call for Pricing



PRG6063



P-60-4



Pressure Gauges & Pressure Reducing Valves

Part Number	Description	Your Price
PRG6063	60 mm Oil-Filled Pressure Gauge; from 0-150 psi; 1/4" MPT	Call for Pricing
P60-4	Watts® Pressure Reducing Valve with 1/4" FPT, Adjustable	Call for Pricing

Installation Accessories

Faucet Adaptors

Part Number	Description	Your Price
FT-05-14QC	Polypropylene Faucet Adaptor 1/2" x 1/2" x 1/4" CCK Quick-Connect Built-in	Call for Pricing
FT-05-38QC	Polypropylene Faucet Adaptor 1/2" x 1/2" x 3/8" CCK Quick-Connect Built-in	Call for Pricing

Self-Piercing Valves

Part Number	Description	Box Qty	Your Price
SV-3	1/4" Tube (Compression), Fits Pipe 3/8" to 1/4"		Call for Pricing
SV-6	1/4" Tube (Compression), Fits Pipe 3/8" to 3/8"		Call for Pricing

FT-05-14QC



FT-05-38QC



SV-3



SV-6



PASVPP1



PASVPP2



ASVPP1LF



ASVPP2LF



ASVPP5LF



ASVPP6LF



John Guest® Angle Stop Adaptor Valves

Part Number	Description	Box Qty	Your Price
PASVPP1	3/8" Male Compression x 3/8" Female Compression x 1/4" - Polypropylene	25	Call for Pricing
PASVPP2	3/8" Male Compression x 3/8" Female Compression x 3/8" - Polypropylene	25	Call for Pricing
ASVPP1LF	3/8" Male Compression x 3/8" Female Comp x 1/4" JG® - Lead Free	30	Call for Pricing
ASVPP2LF	3/8" Male Compression x 3/8" Female Comp x 3/8" JG® - Lead Free	30	Call for Pricing
ASVPP5LF	1/2" Male Compression x 3/8" Female Comp x 1/2" JG® - Lead Free	30	Call for Pricing
ASVPP6LF	1/2" Male Compression x 3/8" Female Comp x 1/2" JG® - Lead Free	20	Call for Pricing

Filter Housings



Watts®/Flowmatic® Housings for Standard 10" & 20" Cartridges

Part Number	Description	Head Color	Sump Color	Port Size	Pressure Release	Buttress Thread	Case Qty	Case Wgt	Your Price
FH4200WW14	Standard 10" Housing – Ridge Cap, NSF	White	White	¼"	No	Yes	12	25 lbs.	Call for Pricing
FH4200BL14	Standard 10" Housing – Ridge Cap, NSF	Black	Blue	¼"	No	Yes	12	25 lbs.	Call for Pricing
FH4200WW34	Standard 10" Housing – Ridge Cap, NSF	White	White	¾"	No	Yes	12	25 lbs.	Call for Pricing
FH4200BL12	Standard 10" Housing – Ridge Cap, NSF	Black	Blue	½"	No	Yes	12	25 lbs.	Call for Pricing

BUTTRESS THREAD DESIGN

ACME THREAD DESIGN



Buttress Threads vs Acme Threads

Buttress Threads provide superior sealing and higher burst ratings than the Acme threads found on most housings. Watts/Flowmatic® and Pentek Housings on this page, and Pentek® 3G Housings on Page 51 all feature buttress threads.





PENTAIR

Pentair's industry-leading filtration systems give you water that is clean, pure, and refreshing every time.



Pentair Filter Housings are manufactured from durable polypropylene or clear Styrene–Acrylonitrile (SAN). Reinforced polypropylene housings have excellent chemical resistance and are ideal for many residential, commercial and industrial applications. Clear sumps are manufactured from FDA compliant Styrene–Acrylonitrile (SAN). They offer on-site examination of the cartridge and have excellent chemical compatibility.

Buttress Thread Design on Pentair 3G Housings provides superior sealing and greater security than housings with standard acme threads.

Buttress Thread Design





Pentek® Filter Housings



Pentek® 3G Slim Line® Housings with Mounting Boss & Buttress Thread

Part Number	Description	Head Color	Sump Color	Port Size	Pressure Release	Case Qty	Case Wgt	Stock	Your Price
158598	10" 3G Slim Line® Blue Housing	Black	Blue	¼" FNPT	Yes	12	32.4 lbs.	S	Call for Pricing
158601	10" 3G Slim Line® White Housing	White	White	¼" FNPT	No	12	32.2 lbs.	S	Call for Pricing
158614	10" 3G Slim Line® Blue Housing	Black	Blue	¾" JG	No	12	32.3 lbs.	S	Call for Pricing



Pentek® 3G Slim Line® Housings with Integrated Bracket & Buttress Thread

Part Number	Description	Head Color	Sump Color	Port Size	Pressure Release	Case Qty	Case Wgt	Stock	Your Price
158643	10" 3G Slim Line® Clear Housing	Blue	Clear	¾" FNPT	Yes	12	27.1 lbs.	S	Call for Pricing
158647	10" 3G Slim Line® White Housing	White	White	¾" JG	Yes	12	33.8 lbs.	S	Call for Pricing

Pentek® Slim Line® Housings



Part Number	Description	Head Color	Sump Color	Port Size	Pressure Release	Case Qty	Case Wgt	Stock	Your Price
158002	5" Slim Line® Blue Housing	Black	Blue	¾" FNPT	Yes	12	16 lbs.	NS	Call for Pricing
158098	10" Slim Line® White Housing	White	White	¾" FNPT	Yes	12	26.2 lbs.	S	Call for Pricing
158114	10" Slim Line® Blue Housing	Black	Blue	¼" FNPT	No	12	26.2 lbs.	S	Call for Pricing
158115	10" Slim Line® Blue Housing	Black	Blue	¼" FNPT	Yes	12	26.4 lbs.	S	Call for Pricing
158125	10" Slim Line® White Housing	White	White	¼" FNPT	No	12	26.2 lbs.	S	Call for Pricing
158326	10" Slim Line® Clear Housing	White	Clear	¼" FNPT	No	12	26.4 lbs.	S	Call for Pricing
158005	10" Slim Line® Blue Housing	Black	Blue	¾" FNPT	Yes	12	26.4 lbs.	S	Call for Pricing
158006	10" Slim Line® Blue Housing	Black	Blue	¾" FNPT	No	12	26.2 lbs.	S	Call for Pricing
158007	10" Slim Line® Clear Housing	Blue	Clear	¾" FNPT	Yes	12	26.4 lbs.	S	Call for Pricing
158195	10" Slim Line® Blue Housing	Black	Blue	½" FNPT	Yes	12	26.4 lbs.	S	Call for Pricing
158214	10" Slim Line® Clear Housing	Blue	Clear	½" FNPT	Yes	12	22.4 lbs.	S	Call for Pricing
158765	10" Slim Line® White Housing	White	White	½" FNPT	No	12	26.2 lbs.	S	Call for Pricing
158204	20" Slim Line® Blue Housing	Black	Blue	½" FNPT	Yes	8	37 lbs.	S	Call for Pricing
158841	20" Slim Line® White Housing	White	White	½" FNPT	Yes	8	27.8 lbs.	S	Call for Pricing



Pentek® 3G Standard Housings with Buttress Thread

Part Number	Description	Head Color	Sump Color	Port Size	Pressure Release	Case Qty	Case Wgt	Stock	Your Price
150546	10" 3G Standard Blue Housing	Black	Blue	¾" FNPT	No	12	38.6 lbs.	S	Call for Pricing
150544	20" 3G Standard Blue Housing	Black	Blue	¾" FNPT	Yes	8	32.9 lbs.	S	Call for Pricing

Pentek® Standard Housings & Valve-in-Head Housings



Part Number	Description	Head Color	Sump Color	Port Size	Pressure Release	Case Qty	Case Wgt	Stock	Your Price
150067	10" Standard Housing w/ Mounting Boss	Black	Blue	¾" FNPT	Yes	12	37.4 lbs.	S	Call for Pricing
150164	10" Standard Housing w/ Valve-in-Head	Black	Blue	¾" FNPT	Yes	12	44 lbs.	NS	Call for Pricing
150071	10" Standard Housing w/ Mounting Boss	Blue	Clear	¾" FNPT	Yes	12	34.9 lbs.	S	Call for Pricing
150435	10" Standard Housing w/ Mounting Boss	Black	Clear	¾" FNPT	Yes	12	38.2 lbs.	S	Call for Pricing
150437	10" Standard Housing w/ Valve-in-Head	Blue	Clear	¾" FNPT	Yes	12	43 lbs.	S	Call for Pricing
150070	20" Standard Housing w/ Mounting Boss	Black	Blue	¾" FNPT	No	8	37.3 lbs.	S	Call for Pricing
150069	20" Standard Housing w/ Mounting Boss	Black	Blue	¾" FNPT	Yes	8	37.5 lbs.	S	Call for Pricing
150166	20" Standard Housing w/ Valve-in-Head	Black	Blue	¾" FNPT	Yes	8	40 lbs.	S	Call for Pricing

Pentek® Big Blue® & Big Clear® Housings



Part Number	Description	Head Color	Sump Color	Port Size	Pressure Release	Case Qty	Case Wgt	Stock	Your Price
150469	10" Big Blue® Housing	Black	Blue	¾" FNPT	Yes	6	33.4 lbs.	S	Call for Pricing
150238	10" Big Blue® Housing	Black	Blue	1" FNPT	No	6	33.1 lbs.	S	Call for Pricing
150237	10" Big Blue® Housing	Black	Blue	1" FNPT	Yes	6	33.4 lbs.	S	Call for Pricing
150426	10" Big Black® Housing	Black	Black	1" FNPT	Yes	6	33.4 lbs.	S	Call for Pricing
166219	10" Big Clear® Housing	Blue	Clear	1" FNPT	Yes	6	33.4 lbs.	S	Call for Pricing
150239	10" Big Blue® Housing	Black	Blue	1½" FNPT	Yes	6	34.6 lbs.	S	Call for Pricing
150240	10" Big Blue® Housing	Black	Blue	1½" FNPT	No	6	33.4 lbs.	NS	Call for Pricing
150467	20" Big Blue® Housing	Black	Blue	¾" FNPT	Yes	4	27.9 lbs.	S	Call for Pricing
150234	20" Big Blue® Housing	Black	Blue	1" FNPT	No	4	27.6 lbs.	S	Call for Pricing
150233	20" Big Blue® Housing	Black	Blue	1" FNPT	Yes	4	27.9 lbs.	S	Call for Pricing
150383	20" Big Black® Housing	Black	Black	1" FNPT	Yes	4	27.6 lbs.	S	Call for Pricing
166201	20" Big Clear® Housing	Blue	Clear	1" FNPT	Yes	4	27.9 lbs.	S	Call for Pricing
150235	20" Big Blue® Housing	Black	Blue	1½" FNPT	Yes	4	29.7 lbs.	S	Call for Pricing
150236	20" Big Blue® Housing	Black	Blue	1½" FNPT	No	4	29.7 lbs.	S	Call for Pricing



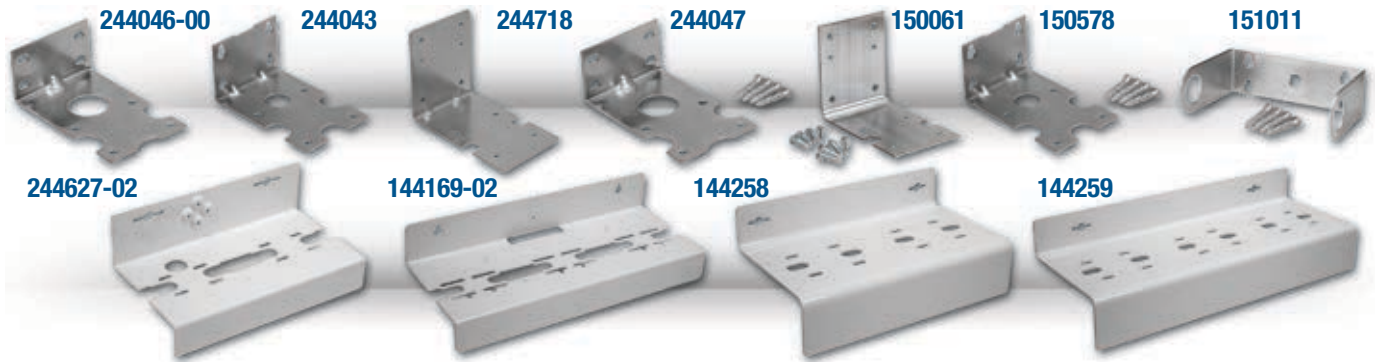

PENTAIR Pentek® Brackets, Wrenches & O-Rings

Pentek® Filter Housing Mounting Brackets

Part Number	Description	Case Qty	Case Wgt	Your Price
244046-00	Bracket ONLY for Pentek® Slim Line Housings	1	0.15 lbs.	Call for Pricing
244043	Bracket ONLY for Pentek® Standard Housings	1	0.41 lbs.	Call for Pricing
244718	Bracket ONLY for Pentek® Big Blue Housings	1	1.72 lbs.	Call for Pricing
150061	Big Blue® Housing Bracket and Screws, Zinc Plated Carbon Steel	25		Call for Pricing
244047	Kit for ¼", ⅜" & ½" Pentek® Slim Line Housing Bracket & Screws	1	0.22 lbs.	Call for Pricing
150578	MC-1A Kit for ¾" Caps w/ Bosses, Bracket & Screws	100	64 lbs.	Call for Pricing
151011	UB-1, WB-SS Kit, Stainless Steel for Pentek® Valve-In-Head Housing Bracket & Screws	1	0.38 lbs.	Call for Pricing
244627-02	Two-Housing CCF & RO System Bracket	15	15 lbs.	Call for Pricing
144169-02	Three Housing CCF & RO System Bracket	1	1 lbs.	Call for Pricing
144258	Two-Housing Pentek® Big Blue Bracket	1	3.2 lbs.	Call for Pricing
144259	Three-Housing Pentek® Big Blue Bracket	1	N/A	Call for Pricing

Pentek® Filter Housing Wrenches



Item Number	Part Number	Description	Your Price
150539	SW-1A	Housing Wrench for Pentek® Slim Line Housings	Call for Pricing
150295-06	SW-2	Housing Wrench for Pentek® Standard Housings	Call for Pricing
150296	SW-3	Housing Wrench for Pentek® #10 Big Blue Housings	Call for Pricing
SH144368	SW-4	Housing Wrench for Pentek® #20 Big Blue Housings	Call for Pricing
SH144880	BW/BC	Housing Wrench for Pentek® for Clear Big Blue Housings	Call for Pricing

Pentek® recommends replacing O-rings annually and using a housing wrench only to loosen a filter housing. Housings can be tightened sufficiently by hand and should not be overtightened.

Pentek® Filter Housing O-Rings



Part Number	Description	Your Price
151120	O-ring for #10, #12, & #20 Housings	Call for Pricing
151121	O-ring for #5, #10 & #20 Slim Line® Housings	Call for Pricing
151122	O-ring – Buna-N for Big Blue Housings	Call for Pricing
151254	Square Cut O-ring – Buna-N for 10" Big Clear Housings	Call for Pricing
151362	O-ring – Buna-N for 20" Big Clear Housings	Call for Pricing

Filter Housing Wrenches, O-Rings & Brackets

Filter Housing Wrenches



Part Number	Description	Your Price
HW100	Spanner Wrench for 4200 & 7000 Housings	Call for Pricing
HW100-MH	Spanner Wrench for Membrane Housing and 4200 & 7000 Housings	Call for Pricing
HW200	Spanner Wrench for 4500 & 8000 Housings	Call for Pricing
HW500	Spanner Wrench for 5000, 10000 & YTB Housings	Call for Pricing
21401240	Hydrotech Housing Wrench for 1240 Series Manifold RO	Call for Pricing

Filter Housing O-Rings



Part Number	Description	Your Price
OR4200	O-Ring for FW4200 Housings	Call for Pricing
OR140-BN70	O-Ring for Membrane Housing	Call for Pricing
OR237-BN70	O-Ring for FH4200 & FH7000 Housings	Call for Pricing
OR238-BN70	O-Ring for AP101T	Call for Pricing
OR240-BN70	O-Ring for YT Housings	Call for Pricing
OR241-BN70	O-Ring for Pentek® #10 & #20 Housings	Call for Pricing
OR242-BN70	O-Ring for 4500 & 8000 Housings	Call for Pricing
OR357-BN70	O-Ring for YTB Big Blue Clear Housings	Call for Pricing
OR358-BN70	O-Ring for 5000 & 10000 Housings	Call for Pricing
OR242-V	Replacement Viton O-Ring for 4500 & 8000 High Temperature Housings	Call for Pricing
2-240BV75	Viton O-Ring for YT-RR 10" & 20" Housings	Call for Pricing
34201026	Hydrotech Replacement O-Ring for Manifold RO Sump	Call for Pricing

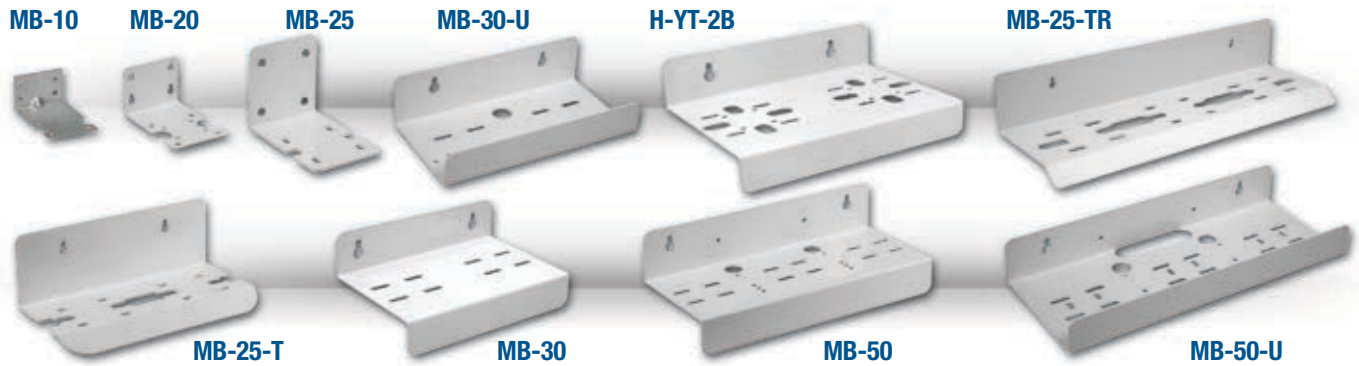

Filter Housing Mounting Brackets

Part Number	Description	Case Qty	Case Wgt	Your Price
MB-10	Single Bracket for 4200 & 7000 Housings	500	53 lbs.	Call for Pricing
MB-20	Single Bracket for YT/Heavy Duty Housings, White – Steel	100	40 lbs.	Call for Pricing
MB-25	Single Bracket for Full-Flow/BB Housings, White – Steel	20	41 lbs.	Call for Pricing
MB-25-T	Twin Bracket for Full-Flow/BB Housings, White – Steel	10	51 lbs.	Call for Pricing
MB-25-TR	Triple Bracket for Full-Flow/BB Housings, White – Steel	N/A	N/A	Call for Pricing
MB-30	Twin Housing Bracket for 4200 Housings, White – Steel	70	95 lbs.	Call for Pricing
MB-50	Triple Housing Bracket for 4200 Housings, White – Steel	30	58 lbs.	Call for Pricing
MB-30-U	Twin Housing U-Shaped Bracket for 4200 Housings, White – Steel	25	15.2 lbs.	Call for Pricing
MB-50-U	Triple Housing U-Shaped Bracket for 4200 Housings, White – Steel	20	17 lbs.	Call for Pricing
FM30	Kemflo/Watts Twin Housing Bracket for 4200/Standard 10" Housings	N/A	N/A	Call for Pricing
H-YT-2B	Twin Bracket for 4500, 8000 & YT Housings	N/A	N/A	Call for Pricing

Mounting Screws



Part Number	Description	Your Price
MS1034	Mounting Screw for 4200 Housing – Stainless Steel	Call for Pricing
MS1010	Mounting Screw for 4200 Housing w/ RO Clip – Stainless Steel	Call for Pricing
MS1410	Mounting Screw for YT/Heavy Duty Housings – Stainless Steel	Call for Pricing
MS5161	Hex Lag Bolt for Full-Flow/BB Housings – Stainless Steel	Call for Pricing
W5161	5/16 Flat Washer – Stainless Steel	Call for Pricing

Booster, Delivery & Permeate Pumps

Aquatec® Booster & Delivery Pumps



Part Number	Item Number	Description	Stock	Your Price
CDP-6800	6840-2J03-B221	Aquatec Booster Pump w/ 1/4" JG Fittings for 50 GPD RO	S	Call for Pricing
CDP-8800	8851-2J03-B423	Aquatec Booster Pump w/ 3/8" JG Fittings for 100 GPD RO	S	Call for Pricing
F5852-1E12-J574		Aquatec 3/8" JG Delivery Pump, 0.8 GPM w/ Cord	NS	Call for Pricing
F5852-7F12-J604		Aquatec 3/8" JG Delivery Pump, 1.7 GPM w/ Cord	S	Call for Pricing



Permeate Pump

Part Number	Description	Your Price
ERP-1000	Aquatec® Permeate Pump, 1/4" JG® Fittings	Call for Pricing

Pump Accessories



Part Number	Description	Your Price
TAS-114-19-EP	Aquatec Transformer for 6800, 115V 0.8 AMP	Call for Pricing
TACS-114-48	Aquatec Transformer for 8800, 115V 2 AMP	Call for Pricing
PSW-240	Aquatec Tank Switch – 40 psi, 1/4" JG 6800 & 8800	Call for Pricing
PSW-340	Aquatec Tank Switch – 40 psi, 3/8" JG 6800 & 8800	Call for Pricing
PPC-1000	Aquatec Clip for ERP-1000	Call for Pricing
LPS	Aquatec Low Pressure Switch for 6800 & 8800	Call for Pricing





HM Digital™ Meters & Monitors

Handheld TDS Meters/PH Tester

Part Number	Description	Stock	Your Price
TDS-3	Most Popular Digital TDS Meter & Thermometer for Professionals; Measures From 0 – 9,990 ppm	S	Call for Pricing
COM-100	Professional Waterproof EC/TDS Meter & Thermometer; Measures From 0-8,560 ppm/ 0-9,990 µS	S	Call for Pricing
ORP-200	Professional Waterproof ORP Meter & Thermometer; Measures from -999 to +1,000 mV	S	Call for Pricing
PH-80	pH/Temperature Waterproof Hydro Tester	S	Call for Pricing

Filter System TDS Meters/Water Flow Monitors

Part Number	Description	Stock	Your Price
DM-1	2-Stage In-Line TDS Monitor	S	Call for Pricing
DM-2	Deluxe In-Line Dual TDS Monitor w/ ¼" Fittings, Water Resistant Case	S	Call for Pricing
FM-1	5-Stage In-Line Monitor (Timer Function Only), with Faucet Indicator Light	S	Call for Pricing

DM-1 Features:

- ◆ Displays TDS levels of the feed water and product water with in & out electrode probes
- ◆ Great instant check for system performance

DM-1



DM-2 Features:

- ◆ Highly efficient and accurate
- ◆ Displays TDS levels of the Feed & Product Water with in & out probes
- ◆ Auto-Off function conserves battery power (Auto shut off after 3 minutes)
- ◆ Factory Calibrated
- ◆ Diagnostic error messaging
- ◆ Shielded sensor cables
- ◆ Comes equipped with two ¼" T-fittings (Also available with ¾" or ½" fittings)

DM-2



Filter Monitor Features:

- ◆ Monitors based on Time
- ◆ Multiple settings and alerts
- ◆ Volumizer
- ◆ Attractive design
- ◆ Innovative flow switch
- ◆ Chrome tri-color faucet disc (works with any standard non-air gap faucet)
- ◆ Color-coded lights indicate filter usage

FM-1



Pro Series Controls Pro Series Replacement Control Valves



Residential Control Valves

Part Number	Description	Flow Rate	Backwash Flow Rate	Inlet/Outlet Port Size	Drain Line (NPT)	Max. Tank Diameter	Your Price
PS1-EM	Pro Series EE Metered Softener Valve	27 GPM	27 GPM	¾", 1" or 1½"	¾" or 1"	21"	Call for Pricing
PS1-TC	Pro Series Time Clock Softener Valve	27 GPM	27 GPM	¾", 1" or 1½"	¾" or 1"	21"	Call for Pricing
PS1-BW	Pro Series Time Clock Backwashing Valve	27 GPM	27 GPM	¾", 1" or 1½"	¾" or 1"	21"	Call for Pricing
PS1-CS	Pro Series Metered Softener Valve	27 GPM	27 GPM	¾", 1" or 1½"	¾" or 1"	21"	Call for Pricing

PS1-EM



EE BOARD CONTROLLER

PS1-TC



TIME CLOCK SOFTENER

PS1-BW



TIME CLOCK BACKWASH

PS1-CS



METER SOFTENER

PS15-EE



PS2-EE



Commercial Control Valves



Part Number	Description	Flow Rate	Backwash Flow Rate	Inlet/Outlet Port Size	Drain Line (NPT)	Max. Tank Diameter	Your Price
PS15-EE	Pro Series EE Softener/Backwash Valve	70 GPM	52 GPM	1½" FNPT	1¼"	24"	Call for Pricing
PS2-EE	Pro Series EE Softener/Backwash Valve	115 GPM	80 GPM	2" FNPT	1½"	48"	Call for Pricing
V3040-15	Used with PS15-EE – Meter Assy 1½"						Call for Pricing
V3094-15	Used with PS2-EE – Meter Assy 2"						Call for Pricing

Pro Series Parts

Part Number	Description	Your Price
D1400	Pro Series In/Out Head w/ Vent Tap	Call for Pricing
V3006	Pro Series Bypass Assembly	Call for Pricing
V3007-15	Pro Series John Guest Elbow Adaptor, ¾"	Call for Pricing
V3007-17	Pro Series John Guest Straight Adaptor, 1"	Call for Pricing
V3007	Pro Series PVC Elbow Adaptor, 1" NPT	Call for Pricing
V3007-01	Pro Series PVC Elbow Assembly, ¾" x 1" Solvent	Call for Pricing
V3010-1D	Injector-D Red – 9" Down, 12" Up	Call for Pricing
V3010-1F	Injector-F Blue – 12" Down, 14" Up	Call for Pricing
V3010-1G	Injector-G Yellow – 13" Down, 16" Up	Call for Pricing
V3010-1H	Injector-H Green – 14" Down, 18" Up	Call for Pricing
V3010-1J	Injector-I Orange – 16" Down, 21" Up	Call for Pricing
V3008-05	Drain Fitting 1" Male NPT w/o Silencer	Call for Pricing
V3193-02	Spanner Wrench, WS1	Call for Pricing
V3022	Stack Puller, WS1	Call for Pricing
V3005-02	Pro Series Spacer Stack Assembly	Call for Pricing
V3186-06	Pro Series Transformer 110v-120v	Call for Pricing

Part Number	Description	Your Price
V3162-013	Pro Series ¾" DLFC Washer – 1.3 GPM	Call for Pricing
V3162-017	Pro Series ¾" DLFC Washer – 1.7 GPM	Call for Pricing
V3162-022	Pro Series ¾" DLFC Washer – 2.2 GPM	Call for Pricing
V3162-027	Pro Series ¾" DLFC Washer – 2.7 GPM	Call for Pricing
V3162-032	Pro Series ¾" DLFC Washer – 3.2 GPM	Call for Pricing
V3162-042	Pro Series ¾" DLFC Washer – 4.2 GPM	Call for Pricing
V3162-053	Pro Series ¾" DLFC Washer – 5.3 GPM	Call for Pricing
V3162-065	Pro Series ¾" DLFC Washer – 6.5 GPM	Call for Pricing
V3162-075	Pro Series ¾" DLFC Washer – 7.5 GPM	Call for Pricing
V3162-090	Pro Series ¾" DLFC Washer – 9.0 GPM	Call for Pricing
V3162-100	Pro Series ¾" DLFC Washer – 10.0 GPM	Call for Pricing
V3190-130	Pro Series 1" DLFC Washer – 13.0 GPM	Call for Pricing
V3190-150	Pro Series 1" DLFC Washer – 15.0 GPM	Call for Pricing
V3190-200	Pro Series 1" DLFC Washer – 20.0 GPM	Call for Pricing
V3190-250	Pro Series 1" DLFC Washer – 25.0 GPM	Call for Pricing
V3175WC-A	Weather Cover, Almond, for PS1, PS1.25 & PS1.5P	Call for Pricing
D1203	Pro Series 1.05" Upper Basket Twist Lock	Call for Pricing
33034	Pro Series 13/16 Upper Basket	Call for Pricing



56/BW



56/16



2510/BW-EC



56SXM & 56SXT



5800



2510BW-AIO



Fleck® Control Valves

Fleck Control Valves

Part Number	Description	Tank Diam. (Softener)	Tank Diam. (GAC Filter)	Flow Rate			Inlet/Outlet Size	Drain Line (NPT)	Your Price
				Continuous	Peak	Max. Backwash			
56/BW	5600 Timer Backwash Filter Control	6-12"	6-10"	20 GPM	26 GPM	7 GPM	¾" or 1"	½"	Call for Pricing
56/16	5600 Timer Softener Control	6-12"	6-10"	20 GPM	26 GPM	7 GPM	¾" or 1"	½"	Call for Pricing
56SXT/BW	5600 Digital Backwash Control	6-12"	6-10"	20 GPM	26 GPM	7 GPM	¾" or 1"	½"	Call for Pricing
56SXT/16	5600 Digital Softener Control	6-12"	6-10"	20 GPM	26 GPM	7 GPM	¾" or 1"	½"	Call for Pricing
56SXM/16	5600 Digital Metered Softener Control	6-12"	6-10"	20 GPM	26 GPM	7 GPM	¾" or 1"	½"	Call for Pricing
5800SXT/BW-E	5800SXT Filter Timer Valve, No DLFC, Black Trim (Backwash only)	6-16"	8-16"	21 GPM	27 GPM	17 GPM	¾" or 1"	½"	Call for Pricing
5800SXT/16-E	5800SXT Softener Timer Valve, No DLFC, Black Trim	6-16"	8-16"	21 GPM	27 GPM	17 GPM	¾" or 1"	½"	Call for Pricing
5800SXM/16-E	5800SXT Softener Metered Valve, No DLFC, Black Trim	6-16"	8-16"	21 GPM	27 GPM	17 GPM	¾" or 1"	½"	Call for Pricing
2510/BW-EC	Time Clock, 12 day, Downflow Filter, 120V/60Hz, U.S. Power Cord, Hardwater Bypass, Environmental Backplate	6-16"	8-16"	19 GPM	24 GPM	17 GPM	¾", 1" or 1¼"	½"	Call for Pricing
2510SXT-AIO	2510SXT BW Valve w/Air Injector	6-16"	8-16"	19 GPM	24 GPM	17 GPM	¾", 1" or 1¼"	½"	Call for Pricing

No DLFC, Call for pricing on any Fleck controls, parts or accessories not listed.

2815SXT



2815NXT



2850



2900



9100



Fleck Control Valves (Continued)

Part Number	Description	Valve Body Material	Tank Diam. (Softener)	Tank Diam. (GAC Filter)	Flow Rate			Inlet/Outlet Size	Drain Line (NPT)	Your Price
					Continuous	Peak	Max. Backwash			
2815NXT2/1720	Fleck, 2815NXT2 Softener Control	Stainless Steel	14-36"	14-30"	70 GPM	70 GPM	70 GPM	1½"	1½"	Call for Pricing
2815NXT2/BW	Fleck, 2815NXT2 Backwash Control	Stainless Steel	14-36"	14-30"	70 GPM	70 GPM	70 GPM	1½"	1½"	Call for Pricing
2815SXT/1720	Fleck, 2815SXT Softener Control	Stainless Steel	14-36"	14-30"	70 GPM	70 GPM	70 GPM	1½"	1½"	Call for Pricing
2815SXT/BW	Fleck, 2815SXT Backwash Control	Stainless Steel	14-36"	14-30"	70 GPM	90 GPM	70 GPM	1½"	1½"	Call for Pricing
2850/1600	Digital Softener Control	Lead-Free Brass	14-36"	14-30"	70 GPM	70 GPM	70 GPM	1½"	1½"	Call for Pricing
2900/1700	Timer Softener Control	Lead-Free Brass	14-36"	14-30"	106 GPM	140 GPM	36 GPM	2"	2"	Call for Pricing
9100SXT	Fleck, 9100SXT Metered Softener Control	Fiber-Reinforced Polymer	6-16"	N/A	20.1 GPM	26 GPM	8.5 GPM	1"	½"	Call for Pricing

No DLFC, Call for pricing on any Fleck controls, parts or accessories not listed.



Fleck Bypasses, Yokes & Connectors

Part Number	Description	Your Price
60040SS	¾" Stainless Bypass for 5600, 5800, 2510, ProFlow & 9000	Call for Pricing
60041SS	1" Stainless Bypass for 5600, 5800, 2510, ProFlow & 9000	Call for Pricing
60049	Noryl Bypass for 5600, 5800, 2510, ProFlow & 9000	Call for Pricing
61694	1" Noryl Yoke Quick-Connect	Call for Pricing
61700	¾" Noryl Yoke Quick-Connect	Call for Pricing
18706	1" Noryl Yoke for 5600, 5800, 2510, ProFlow & 9000	Call for Pricing
18706-02	¾" Noryl Yoke for 5600, 5800, 2510, ProFlow & 9000	Call for Pricing
12338	Drain Elbow Connector, ½" MNPT x ½" Barb	Call for Pricing

60040SS
¾" STAINLESS BYPASS



60041SS
1" STAINLESS BYPASS



60049
NORYL BYPASS



61694 & 61700
NORYL YOKE



18706 & 18706-02
NORYL YOKES



61991-01
1" NPT CONNECTOR ASSEMBLY



61991-03
1¼" NPT CONNECTORS



Drain Line Flow Control Buttons 5600/5800/5810/5812

Part Number	Description	Case Qty	Your Price
12086	1.5 GPM DLFC Button, 0.69" OD	6	Call for Pricing
12087	2.0 GPM DLFC Button, 0.69" OD	6	Call for Pricing
12088	2.4 GPM DLFC Button, 0.69" OD	6	Call for Pricing
12090	3.5 GPM DLFC Button, 0.69" OD	6	Call for Pricing
12092	5.0 GPM DLFC Button, 0.69" OD	6	Call for Pricing
12408	7.0 GPM DLFC Button, 0.69" OD	6	Call for Pricing

Drain Line Flow Control Buttons for Fleck Commercial Controls

Part Number	Description	Case Qty	Your Price
17943	8.0 GPM DLFC Button, 0.95" OD	6	Call for Pricing
17944	9.0 GPM DLFC Button, 0.95" OD	6	Call for Pricing
16529	10.0 GPM DLFC Button, 0.95" OD	6	Call for Pricing
16735	12.0 GPM DLFC Button, 0.95" OD	6	Call for Pricing
16736	15.0 GPM DLFC Button, 0.95" OD	6	Call for Pricing
16528	20.0 GPM DLFC Button, 0.95" OD	6	Call for Pricing
16737	25.0 GPM DLFC Button, 0.95" OD	6	Call for Pricing

Drain Line Flow Control Buttons 5810/5812

Part Number	Description	Case Qty	Your Price
43736	30.0 GPM DLFC Button, 1.4" OD	6	Call for Pricing
43738	40.0 GPM DLFC Button, 1.4" OD	6	Call for Pricing
43739	45.0 GPM DLFC Button, 1.4" OD	6	Call for Pricing



60084-0001
INJECTOR DRAIN ASSEMBLY

18743-1
DRIVE MOTOR

Fleck Replacement Parts

Part Number	Description	Your Price
60084-0001	Injector Drain Assembly, 5600/5600SXT/4650/6700 #0 inj, BLANK DLFC, .25 BLFC	Call for Pricing
18743-1	5600 Drive Motor, 3200/3210/3220/3230/9000/9100/9500 Remote Timer, 120V	Call for Pricing
60090	2510/1500 Piston Assembly, Hard Water Bypass	Call for Pricing
60102-00	5600 Timeclock Softener Piston, White Endplug	Call for Pricing
60102-10	5600 Timeclock Backwash/Filter Piston, Black Endplug	Call for Pricing
60102-71	5600SXT Piston (Softener & B/W), Green Endplug	Call for Pricing
60125	5600/56SXT/6700 Seal & Spacer Kit	Call for Pricing
60121	2510/2750/1500 Seal & Spacer Kit	Call for Pricing
12091	Fleck, Washer, Flow, 4.0 GPM, DLFC	Call for Pricing
13308	Fleck, Hose Barb, ½" MNPT x 1"	Call for Pricing
40674	Fleck, Coupling, Reducer 1" to ¾"	Call for Pricing
41089	Fleck, Clip, Filter Head, 61445-1	Call for Pricing
43740	Washer, Flow, 50.0 GPM	Call for Pricing
43767	Washer, Flow, 60.0 GPM	Call for Pricing

Part Number	Description	Your Price
44161	Fleck, Transformer, US, 12V, 5800/58	Call for Pricing
44182	Fleck, Retainer, DLFC, 2815, 50 - 70	Call for Pricing
61419	Fleck, Distributor Adaptor 1.05	Call for Pricing
61837	Fleck, Piston Assy, Downflow 5800	Call for Pricing
62033	Fleck, DLFC Retainer Assy 1.7-7 GPM	Call for Pricing
62034	Fleck, DLFC Retainer, .95" OD Buttons	Call for Pricing
62035	Fleck, Retainer Assy, 1.4 Flow Washer	Call for Pricing
19228-01	Fleck, Adaptor Coupling, 2510/5600/5	Call for Pricing
19791-02	Fleck, Meter Cable Assy, 35	Call for Pricing
61662-01	Fleck, Seal and Spacer Kit, 2510AIO	Call for Pricing
61933-10	Fleck, Meter Assy, 1½" NPT, STD, S	Call for Pricing
62091-01	Fleck, Powerhead, 5600	Call for Pricing
10913-1	Nozzle, Injector, #1, White (9-10 Tanks)	Call for Pricing
10913-3	Nozzle, Injector, #3, Yellow (13-14 Tanks)	Call for Pricing
10913-4	Nozzle, Injector, #4, Green (14-16 Tanks)	Call for Pricing

Any Fleck parts not listed can be ordered for you.

6" Tanks

Part Number	Description	Color	Opening	Cubic Feet	Gaylord Qty	Your Price
PG635-N	6" x 35"	Blue	2.5"	0.51	33	Call for Pricing

9-10" Tanks

Part Number	Description	Color	Opening	Cubic Feet	Gaylord Qty	Your Price
PG948-BLK	9" x 48"	Black	2.5"	1.6	16	Call for Pricing
PG1040-BLK	10" x 40"	Black	2.5"	1.54	12	Call for Pricing
PG1044-BLK	10" x 44"	Black	2.5"	1.8	12	Call for Pricing
PG1044-AL-NDH-A	10" x 44" DH A w/ Dome Hole	Almond	2.5" w/ Dome Hole	1.8	12	Call for Pricing
PG1054-BLK	10" x 54"	Black	2.5"	2.2	16	Call for Pricing
PG1054-N-DH-A	10" x 54" DH C w/ Dome Hole	Natural	2.5" w/ Dome Hole	2.2	16	Call for Pricing

12-13" Tanks

Part Number	Description	Color	Opening	Cubic Feet	Gaylord Qty	Your Price
PG1252-BLK	12" x 52"	Black	2.5"	2.97	9	Call for Pricing
PG1354-BLK	13" x 54"	Black	2.5"	3.6	9	Call for Pricing
PG1354-AL-NDH-C	13" x 54" DH C w/ Dome Hole	Almond	2.5" w/ Dome Hole	3.6	9	Call for Pricing

14-24" Tanks

Part Number	Description	Color	Opening	Cubic Feet	Gaylord Qty	Your Price
PG1465-4-BLK	14" x 65"	Black	4.0"	5.1	9	Call for Pricing
PG1665-4-BLK	16" x 65"	Black	4.0"	6.6	9	Call for Pricing
CT1865-BLK	18" x 65"	Black	4.0"	8.3	N/A	Call for Pricing
CT2162-BLK	21" x 62"	Black	4.0"	8.56	N/A	Call for Pricing
CT2472-BLK	24" x 72"	Black	4.0"	15.9	N/A	Call for Pricing

Any Structural Tank not listed can be ordered for you.

Structural Polyglass™ Tanks

The highest quality pressure vessel for residential and light commercial water softener/filtration applications. Structural Polyglass™ pressure vessels provide years of reliable service for water softener and water filtration applications. These slim-diameter tanks hold up to 49 gallons of water and offer unmatched strength and chemical resistance.

All Polyglass™ residential tanks are backed by an exclusive 10-year warranty. Structural's patented manufacturing process creates a seamless polyethylene shell that is wound

continuously with miles of fiberglass reinforcements and sealed with epoxy resin. Computer-aided winding machines and other customized equipment are used to create a product that offers outstanding performance and durability.

Structural pressure vessels provide cost-effective solutions for the most challenging applications. Using the latest technologies, Structural critically evaluates every design detail to ensure their products meet or exceed ISO, AMSE, NSF, & other agency standards.



Tank Jackets

Part Number	Description	Your Price
NTJ-9	Neoprene Tank Jacket, Black, 9" x 48"	Call for Pricing
NTJ-10	Neoprene Tank Jacket, Black, 10" x 54"	Call for Pricing
NTJ-12	Neoprene Tank Jacket, Black, 12" x 52"	Call for Pricing
NTJ-13	Neoprene Tank Jacket, Black, 13" x 54"	Call for Pricing



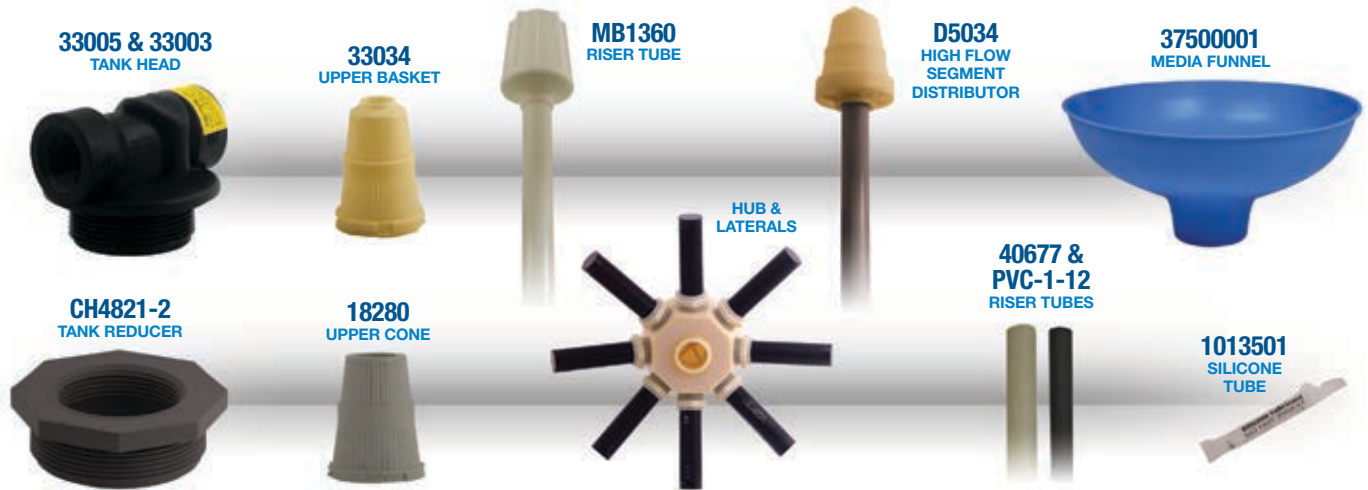

Fleck Bypasses, Yokes & Connectors

Part Number	Description	Your Price
33005	Pro Series ¾" In/Out Head	Call for Pricing
33003	Pro Series 1" In/Out Head	Call for Pricing
33034	13/16" Upper Basket	Call for Pricing
18280	1" Upper Cone	Call for Pricing
50010010	1" x 72" High Flow Segment Distributor	Call for Pricing
D5034	1.05" x 60" Riser Tube (Mattson/Witt)	Call for Pricing
MB1360	13/16" x 60" Riser Tube (Mattson/Witt)	Call for Pricing
37500001	2½" x 8" Media Funnel	Call for Pricing
CH4821-2	Tank Reducer 4" to 2½"	Call for Pricing
40677	32mm Riser Tube for Use w/ Hub and Laterals - 72"	Call for Pricing
D1074	Pro Series Hub, 1½" Solvent	Call for Pricing
D7186	Pro Series Lateral, 18", 21" and 24" Tanks	Call for Pricing
D7185	Pro Series Lateral, 14" and 16" Tanks	Call for Pricing
PVC-1-12	1" Riser for Hub & Lateral - No Basket	Call for Pricing
1013501	Single-Use Silicone O-Ring Lubricant	Call for Pricing
21774	Structural Dome Hole Plug (New Style)	Call for Pricing

Brine Tanks

Part Number	Description	Gallons (Liters)	Salt Cap.	Dimensions	Color	Your Price
30020023	Square Brine Tank w/ Safety Float & Salt Grid	25 (94.5)	230 lbs.	15"W x 15"W x 32"H	Black	Call for Pricing
30020011	Round Brine Tank w/ Safety Float & Salt Grid	42 (160)	385 lbs.	19"D x 35"H	Black	Call for Pricing
30020032	Round Brine Tank w/ Safety Float & Salt Grid	53 (200)	700 lbs.	23"D x 37"H	Grey	Call for Pricing
55010018	Brine Well Assembly w/ Safety, Aircheck BTS-70, BTR-100, BTS-100					Call for Pricing



STRUCTURAL®



30020032
BRINE TANK

30020011
BRINE TANK

30020023
BRINE TANK





45 or 85 Fixed Rate Pumps

Part Number	Description	Ship Wgt	Your Price
45MFH1A1SUAA	3.0 GPD @ 100 psi Stenner Chemical Feed Pump	8 lbs.	Call for Pricing
45MFH2A1SUAA	10.0 GPD @ 100 psi Stenner Chemical Feed Pump	8 lbs.	Call for Pricing
45MFH7A1SUAA	22.0 GPD @ 100 psi Stenner Chemical Feed Pump	8 lbs.	Call for Pricing
85MFH1A1SUAA	5.0 GPD @ 100 psi Stenner Chemical Feed Pump	8 lbs.	Call for Pricing
85MFH2A1SUAA	17.0 GPD @ 100 psi Stenner Chemical Feed Pump	8 lbs.	Call for Pricing
85MFH7A1SUAA	40.0 GPD @ 100 psi Stenner Chemical Feed Pump	8 lbs.	Call for Pricing

¾" Suction Tube available for an additional \$15.

45 or 85 Adjustable Rate Pumps



Part Number	Description	Ship Wgt	Your Price
45MJH1A1STAA	0.2 to 3.0 GPD @ 100 psi Stenner Chemical Feed Pump	9 lbs.	Call for Pricing
45MJH1B1STAA	3.0 GPD @ 100 psi Stenner Chemical Feed Pump	9 lbs.	Call for Pricing
45MJH2A1STAA	0.5 to 10.0 GPD @ 100 psi Stenner Chemical Feed Pump	9 lbs.	Call for Pricing
45MJH2B1STAA	45 GPD Adjustable Rate Pump 220 Volt.	9 lbs.	Call for Pricing
45MJH2B2STAA	0.5 to 10 GPD @ 100 psi Stenner Chemical Feed Pump	9 lbs.	Call for Pricing
45MJH7A1STAA	1.1 to 22.0 GPD @ 100 psi Stenner Chemical Feed Pump	9 lbs.	Call for Pricing
85MJH1A1STAA	0.3 to 5.0 GPD @ 100 psi Stenner Chemical Feed Pump	9 lbs.	Call for Pricing
85MJH1B1STAA	0.3 to 5.0 GPD @ 100 psi Stenner Chemical Feed Pump	9 lbs.	Call for Pricing
85MJH2A1STAA	0.8 to 17.0 GPD @ 100 psi Stenner Chemical Feed Pump	9 lbs.	Call for Pricing
85MJH2A3STAA	0.8 to 17.0 GPD @ 100 psi Stenner Chemical Feed Pump	9 lbs.	Call for Pricing
85MJH7A1STAA	2.0 to 40.0 GPD @ 100 psi Stenner Chemical Feed Pump	9 lbs.	Call for Pricing
85MJH7A3STAA	2.0 to 40.0 GPD @ 100 psi Stenner Chemical Feed Pump	9 lbs.	Call for Pricing
85MJH7B1STAA	2.0 to 40.0 GPD @ 100 psi Stenner Chemical Feed Pump	9 lbs.	Call for Pricing

¾" Suction Tube available for an additional \$15.



ECON FP Pumps

Part Number	Description	Ship Wgt	Your Price
E20MH81S6	ECON Stennicator 2.70 oz./Min @ 80 psi	4 lbs.	Call for Pricing
E20PHF81S7	4.5 GPD Flow Activated Chemical Feed Pump	4 lbs.	Call for Pricing
E20PHG81S11	16 GPD Flow Activated Chemical Feed Pump	4 lbs.	Call for Pricing
E20PHH81S11	30 GPD Flow Activated Chemical Feed Pump	4 lbs.	Call for Pricing



Solution Tanks

Part Number	Description	Ship Wgt	Your Price
STS7GC	7.5 Gal Solution Tank – UV Resistant Grey	15 lbs.	Call for Pricing
STS7NC	7.5 Gal Solution Tank – Translucent White	15 lbs.	Call for Pricing
STS15GC	15 Gal Solution Tank – UV Resistant Grey	18 lbs.	Call for Pricing
STS15NC	15 Gal Solution Tank – Translucent White	18 lbs.	Call for Pricing
STS30GC	30 Gal Solution Tank – UV Resistant Grey	24 lbs.	Call for Pricing
STS30NC	30 Gal Solution Tank – Translucent White	24 lbs.	Call for Pricing

7.5 GALLON

15 GALLON

30 GALLON



Replacement Components

Part Number	Description	Your Price
UCCP1FD	2 Pack Santoprene® #1 Discharge Tube w/ Duckbill & Ferrules	Call for Pricing
UCCP2FD	2 Pack Santoprene® #2 Discharge Tube w/ Duckbill & Ferrules	Call for Pricing
UCCP7FD	2 Pack Santoprene® #7 Discharge Tube w/ Duckbill & Ferrules	Call for Pricing
QP500-1	QP Roller Assbly – 1 Pack	Call for Pricing
QP500-4	QP Roller Assbly – 4 Pack	Call for Pricing
QP101-1	QuickPro Pump Head w/ #1 Discharge Tube	Call for Pricing
QP102-1	QuickPro Pump Head w/ #2 Discharge Tube	Call for Pricing
MCCVDB0	5 Pack Santoprene Check Valve Duckbills	Call for Pricing
FSK100	Feed Rate Service Control Kit – Adjustable Models Only (MJH)	Call for Pricing

Pump Accessories

Part Number	Description	Your Price
AK600	Flow Indicator ¼" w/ Bracket	Call for Pricing
AK700	Flow Indicator ½" w/ Bracket	Call for Pricing
MP90000	Rain Roof for Classic Pump	Call for Pricing
PCM5	Pump Control Module – for Fixed Models Only (MFH)	Call for Pricing





ACID WASHED, COCONUT SHELL GAC

Ideal for chlorine removal in whole house applications



NSF Certified Component

- ◆ 12 x 40 Mesh Size
- ◆ 1 Cubic Foot Bags
- ◆ Net Weight: 27.85 & 28.05 lbs.



Granular Activated Carbon Media



Part Number	Description	Mesh Size	Bag Size	Wgt	Stock	Your Price
HS-12x40	AquaSorb® 1 ft³ Bag of Coconut Shell GAC, NSF 42 Certified	12 x 40	1.0 ft³	27.85 lbs.	S	Call for Pricing
CX-MCA	AquaSorb® 1 ft³ Bag of Catalytic Carbon, NSF 61 Certified	12 x 40	1.0 ft³	28.05 lbs.	S	Call for Pricing



Coconut shell activated carbon has a very high hardness and is more abrasion resistant than any other type. It is a totally natural, environmentally friendly product that has a very small carbon footprint, since it is derived from coconut shells. As most of its pore structure consists of micropores (more than 80%), coconut shell carbon can efficiently absorb impurities with micropore molecular structure, such as those present in drinking water. In addition, because of its high abrasion resistance and exceptional chemical and physical characteristics, only coconut shell activated carbon can support applications such as recovery of gold and other precious metals.

The very large internal surface areas characterized by microporosity along with high hardness and low dust make these coconut shell carbons particularly attractive for water and critical air applications as well as point-of-use water filters and respirators.

Features:

- ◆ Highly effective for removal of trace level organics
- ◆ Acid washed to reduce ash and enhance purity
- ◆ Highly microporous and high surface area
- ◆ Excellent mechanical hardness

Coconut Shell Carbon (HS-12x40)

AquaSorb® HS is an acid washed high purity high activity granular activated carbon manufactured by steam activation from carefully selected coconut shells. This activated carbon is produced for use in ultra-pure water treatment systems requiring low conductivity and exceptionally high purity. This activated carbon is also specifically designed for the removal of heavy hydrocarbons from recovered condensate. The acid washing process removes soluble silica from the matrix of the activated carbon to prevent leaching into the condensate.

Specifications:

- ◆ NSF / ANSI 42 Certified
- ◆ Surface Area - 1,050 m²/g
- ◆ CTC Activity - 55%
- ◆ Iodine Nuber - 1,000 mg/g min.
- ◆ Moisture Content - 5% max.
- ◆ Total Ash Content - 1% max.
- ◆ pH - 5 - 7
- ◆ Hardness - 98% min.

Catalytic Carbon (CX-MCA)

AquaSorb® CX-MCA is a catalytic, high activity granular activated carbon manufactured by steam activation of select coconut shell charcoal. The catalytic activity of this activated carbon makes it highly effective for the removal of chloramines and hydrogen sulfide from potable water. Its large micropore volume makes it particularly well suited for the removal of low molecular weight organic compounds and their chlorinated by-products such as chloroform and other trihalomethanes (THMs). An important feature of this material is its superior mechanical hardness and the extensive dedusting during its manufacture ensures an exceptionally clean activated carbon product.

Specifications:

- ◆ NSF / ANSI 61 Certified
- ◆ Surface Area (BET) - 1,060 m²/g
- ◆ CTC Activity - 50% min.
- ◆ Apparent Density - 514 kg/m³
- ◆ Bed Density, Backwashed & Drained - 437 kg/m³
- ◆ Iodine Nuber - 1,000 mg/g min.
- ◆ Moisture Content - 5% max.
- ◆ Total Ash Content - 4% max.
- ◆ pH - 10
- ◆ Ball-pan Hardness - 98% min.
- ◆ Catalytic Activity - 20° C min.



Clack® Granular Activated Carbon Media

Part Number	Description	Mesh Size	Bag Size	Wgt	Stock	Your Price
CS-HAC	Clack® 1 ft³ Bag of Coconut Shell GAC, NSF 61 Certified	12 x 40	1.0 ft³	29 lbs.	S	Call for Pricing



CALCITE
Large Inventory of
Calcite in Stock for
Immediate Shipment



**KATALOX
LIGHT**

pH Correction Medias

Part Number	Description	Bag Size	Wgt	Stock	Your Price
Calcite-50IM-BG	Calcium Carbonate Mineral, 50 lb. Bag	0.5 ft³	50 lbs.	S	Call for Pricing
Fiomag-50MM-BG	Magnesium Oxide Mineral, 50 lb. Bag	0.5 ft³	50 lbs.	S	Call for Pricing

Iron & Sediment Removal Medias

Part Number	Description	Bag Size	Wgt	Stock	Your Price
A7200	Micro-Z – Sediment Removal Media	1.0 ft³	56 lbs.	S	Call for Pricing
A8033	Filox – Iron Removal Media	0.5 ft³	56 lbs.	S	Call for Pricing
KL	Katalox Light – Iron Removal Media	1.0 ft³	66 lbs.	S	Call for Pricing

Resins

Softening Resins

Part Number	Description	Crosslink	Bag Size	Wgt	Stock	Your Price
CG8	8% Cation Softening Resin, 1 Cu Ft Bag	8%	1.0 ft³	51 lbs.	S	Call for Pricing
CG10	10% Cation Softening Resin, 1 Cu Ft Bag	10%	1.0 ft³	53 lbs.	S	Call for Pricing

Strong Base Anion Resins

Part Number	Description	Bag Size	Wgt	Stock	Your Price
SBG1	Type 1 Strong Base Anion Resin – Chloride Form	1.0 ft³	44 lbs.	NS	Call for Pricing
SBG1-HP	Type 1 Strong Base Anion Resin – High Purity, Chloride Form	1.0 ft³	44 lbs.	NS	Call for Pricing
SBG2	Type 2 Strong Base Anion Resin – Chloride Form	1.0 ft³	44 lbs.	NS	Call for Pricing
SBG2-HP	Type 2 Strong Base Anion Resin – High Purity, Chloride Form	1.0 ft³	44 lbs.	NS	Call for Pricing

Mixed Bed DI Resins

Part Number	Description	Bag Size	Wgt	Stock	Your Price
MBD-10-SC	Mixed Bed Resin – Semiconductor Grade	1.0 ft³	43 lbs.	NS	Call for Pricing
MBD-30	Mixed Bed Resin – Color Changing	1.0 ft³	43 lbs.	NS	Call for Pricing



**ION
EXCHANGE
RESIN**

RESINTECH INC
www.resintech.com



Specialty Resins

Part Number	Description	Bag Size	Wgt	Stock	Your Price
SIR-100-HP	Nitrate Selective Resin	1.0 ft³	42 lbs.	NS	Call for Pricing
SIR-22P-HP	Tannin Removal Resin	1.0 ft³	41 lbs.	NS	Call for Pricing
SIR-900	Fluoride Reduction Resin	1.0 ft³	42 lbs.	NS	Call for Pricing

Gravel

Part Number	Description	Bag Size	Wgt	Stock	Your Price
Gravel-50RF-BG	Gravel Under Bedding, Red Flint, ¼" x ⅝" 50 Pound Bags, 0.5 ft³	0.5 ft³	50 lbs.	S	Call for Pricing

Non-Stock Items are drop shipped directly by our supplier.

Stainless Steel Connectors

Part Number	Description	Your Price
NI.75HEX150#304	¾" Hex Nipple 150# 304	Call for Pricing
NI.75X3.00S40304	¾" x 3 Nipple SCH 40 304/304L	Call for Pricing
NI.75X5.00S40304	¾" x 5 Nipple SCH 40 304/304L	Call for Pricing
NI1.00HEX150#304	1" Hex Nipple	Call for Pricing
NI1.00X3.00S40304	1" x 3" SS Nipple	Call for Pricing
NI1.00X5.00S40304	1" x 5" SS Nipple	Call for Pricing

NI.75HEX150#304



NI.75X3.00S40304



NI.75X5.00S40304



NI1.00HEX150#304



NI1.00X3.00S40304

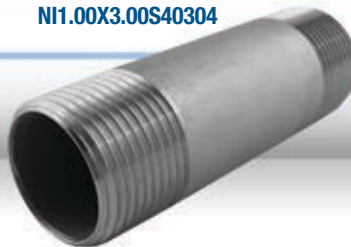

NI1.00X5.00S40304



Whole House Carbon Filters

Backwashing Whole House Carbon Filters with Pro Series Valve

Part Number*	Control Valve	Tank Size	Tank Type	Connection Size	Carbon Type	Carbon Mesh Size	Carbon Amount	Flow Rate	Your Price
PS1BW-1.0-GAC*	Pro Series PS1-BW	9" x 48"	Structural®	¾" or 1"	Coconut Shell	12" x 40"	1.0 ft³	4-5 GPM	Call for Pricing
PS1BW-1.5-GAC*	Pro Series PS1-BW	10" x 54"	Structural®	¾" or 1"	Coconut Shell	12" x 40"	1.5 ft³	5-7 GPM	Call for Pricing
PS1BW-2.0-GAC*	Pro Series PS1-BW	12" x 52"	Structural®	¾" or 1"	Coconut Shell	12" x 40"	2.0 ft³	8-10 GPM	Call for Pricing
PS1BW-2.5-GAC*	Pro Series PS1-BW	13" x 54"	Structural®	¾" or 1"	Coconut Shell	12" x 40"	2.5 ft³	10-12 GPM	Call for Pricing
PS1BW-3.0-GAC*	Pro Series PS1-BW	14" x 65"	Structural®	¾" or 1"	Coconut Shell	12" x 40"	3.0 ft³	12-15 GPM	Call for Pricing
PS1BW-4.0-GAC*	Pro Series PS1-BW	16" x 65"	Structural®	¾" or 1"	Coconut Shell	12" x 40"	4.0 ft³	16-20 GPM	Call for Pricing
PS1BW-5.0-GAC*	Pro Series PS1-BW	18" x 65"	Structural®	¾" or 1"	Coconut Shell	12" x 40"	5.0 ft³	20-25 GPM	Call for Pricing
PS1BW-7.0-GAC*	Pro Series PS1-BW	21" x 62"	Structural®	¾" or 1"	Coconut Shell	12" x 40"	7.0 ft³	28-35 GPM	Call for Pricing
PS1BW-1.0-CC*	Pro Series PS1-BW	9" x 48"	Structural®	¾" or 1"	Catalytic	12" x 40"	1.0 ft³	4-5 GPM	Call for Pricing
PS1BW-1.5-CC*	Pro Series PS1-BW	10" x 54"	Structural®	¾" or 1"	Catalytic	12" x 40"	1.5 ft³	5-7 GPM	Call for Pricing
PS1BW-2.0-CC*	Pro Series PS1-BW	12" x 52"	Structural®	¾" or 1"	Catalytic	12" x 40"	2.0 ft³	8-10 GPM	Call for Pricing
PS1BW-2.5-CC*	Pro Series PS1-BW	13" x 54"	Structural®	¾" or 1"	Catalytic	12" x 40"	2.5 ft³	10-12 GPM	Call for Pricing
PS1BW-3.0-CC*	Pro Series PS1-BW	14" x 65"	Structural®	¾" or 1"	Catalytic	12" x 40"	3.0 ft³	12-15 GPM	Call for Pricing
PS1BW-4.0-CC*	Pro Series PS1-BW	16" x 65"	Structural®	¾" or 1"	Catalytic	12" x 40"	4.0 ft³	16-20 GPM	Call for Pricing
PS1BW-5.0-CC*	Pro Series PS1-BW	18" x 65"	Structural®	¾" or 1"	Catalytic	12" x 40"	5.0 ft³	20-25 GPM	Call for Pricing
PS1BW-7.0-CC*	Pro Series PS1-BW	21" x 62"	Structural®	¾" or 1"	Catalytic	12" x 40"	7.0 ft³	28-35 GPM	Call for Pricing
PS1EM-1.0-CC*	Pro Series PS1-EM	9" x 48"	Structural®	¾" or 1"	Catalytic	12" x 40"	1.0 ft³	4-5 GPM	Call for Pricing
PS1EM-1.5-CC*	Pro Series PS1-EM	10" x 54"	Structural®	¾" or 1"	Catalytic	12" x 40"	1.5 ft³	5-7 GPM	Call for Pricing
PS1EM-2.0-CC*	Pro Series PS1-EM	12" x 52"	Structural®	¾" or 1"	Catalytic	12" x 40"	2.0 ft³	8-10 GPM	Call for Pricing
PS1EM-2.5-CC*	Pro Series PS1-EM	13" x 54"	Structural®	¾" or 1"	Catalytic	12" x 40"	2.5 ft³	10-12 GPM	Call for Pricing

*Tail pieces are sold separately.

PS1BW-1.0

PS1BW-1.5

PS1BW-2.0

PS1BW-2.5

PS1BW-3.0

PS1BW-4.0

PS1BW-5.0

PS1BW-7.0



Pro Series
Controls



Backwashing Whole House Carbon Filters with Fleck® Valve



Part Number	Control Valve	Tank Size	Tank Type	Conn. Size	Bypass Type	Carbon Type	Carbon Mesh Size	Carbon Amount	Flow Rate	Your Price
58SXT-1.0-GAC	Fleck® 5800	9" x 48"	Structural®	¾"	Stainless Steel	Coconut Shell	12" x 40"	1.0 ft³	4-5 GPM	Call for Pricing
58SXT-1.5-GAC	Fleck® 5800	10" x 54"	Structural®	¾"	Stainless Steel	Coconut Shell	12" x 40"	1.5 ft³	5-7 GPM	Call for Pricing
58SXT-2.0-GAC	Fleck® 5800	12" x 52"	Structural®	1"	Stainless Steel	Coconut Shell	12" x 40"	2.0 ft³	8-10 GPM	Call for Pricing
58SXT-2.5-GAC	Fleck® 5800	13" x 54"	Structural®	1"	Stainless Steel	Coconut Shell	12" x 40"	2.5 ft³	10-12 GPM	Call for Pricing
58SXT-3.0-GAC	Fleck® 5800	14" x 65"	Structural®	1"	Stainless Steel	Coconut Shell	12" x 40"	3.0 ft³	12-15 GPM	Call for Pricing
58SXT-4.0-GAC	Fleck® 5800	16" x 65"	Structural®	1"	Stainless Steel	Coconut Shell	12" x 40"	4.0 ft³	16-20 GPM	Call for Pricing
58SXT-1.0-CC	Fleck® 5800	9" x 48"	Structural®	¾"	Stainless Steel	Catalytic	12" x 40"	1.0 ft³	4-5 GPM	Call for Pricing
58SXT-1.5-CC	Fleck® 5800	10" x 54"	Structural®	¾"	Stainless Steel	Catalytic	12" x 40"	1.5 ft³	5-7 GPM	Call for Pricing
58SXT-2.0-CC	Fleck® 5800	12" x 52"	Structural®	1"	Stainless Steel	Catalytic	12" x 40"	2.0 ft³	8-10 GPM	Call for Pricing
58SXT-2.5-CC	Fleck® 5800	13" x 54"	Structural®	1"	Stainless Steel	Catalytic	12" x 40"	2.5 ft³	10-12 GPM	Call for Pricing
58SXT-3.0-CC	Fleck® 5800	14" x 65"	Structural®	1"	Stainless Steel	Catalytic	12" x 40"	3.0 ft³	12-15 GPM	Call for Pricing
58SXT-4.0-CC	Fleck® 5800	16" x 65"	Structural®	1"	Stainless Steel	Catalytic	12" x 40"	4.0 ft³	16-20 GPM	Call for Pricing
56SXT-1.0-GAC	Fleck® 5600	9" x 48"	Structural®	¾"	Stainless Steel	Coconut Shell	12" x 40"	1.0 ft³	4-5 GPM	Call for Pricing
56SXT-1.5-GAC	Fleck® 5600	10" x 54"	Structural®	¾"	Stainless Steel	Coconut Shell	12" x 40"	1.5 ft³	5-7 GPM	Call for Pricing
56SXT-2.0-GAC	Fleck® 5600	12" x 52"	Structural®	¾"	Stainless Steel	Coconut Shell	12" x 40"	2.0 ft³	8-10 GPM	Call for Pricing
56SXT-2.5-GAC	Fleck® 5600	13" x 54"	Structural®	¾"	Stainless Steel	Coconut Shell	12" x 40"	2.5 ft³	10-12 GPM	Call for Pricing
56SXT-1.0-CC	Fleck® 5600	9" x 48"	Structural®	¾"	Stainless Steel	Catalytic	12" x 40"	1.0 ft³	4-5 GPM	Call for Pricing
56SXT-1.5-CC	Fleck® 5600	10" x 54"	Structural®	¾"	Stainless Steel	Catalytic	12" x 40"	1.5 ft³	5-7 GPM	Call for Pricing
56SXT-2.0-CC	Fleck® 5600	12" x 52"	Structural®	¾"	Stainless Steel	Catalytic	12" x 40"	2.0 ft³	8-10 GPM	Call for Pricing
56SXT-2.5-CC	Fleck® 5600	13" x 54"	Structural®	¾"	Stainless Steel	Catalytic	12" x 40"	2.5 ft³	10-12 GPM	Call for Pricing

56SXT-1.0 56SXT-1.5 58SXT-2.0 58SXT-2.5 58SXT-3.0 58SXT-4.0



Structural® Polyglass™ Pressure Vessel w/ Coconut Shell Catalytic GAC & Tank Head



Part Number	Tank Head	Tank Size	Color	Carbon Type	Carbon Amount	Port Size	Flow Rate	Case Qty	Your Price
WHR300	Pro Series	6" x 35"	Blue	Catalytic	0.6 ft³	¾"	2-3 GPM	1	Call for Pricing
WHR935	Pro Series	9" x 35"	Natural	Catalytic	1.0 ft³	¾"	3-4 GPM	1	Call for Pricing
WHR948	Pro Series	9" x 48"	Black	Catalytic	1.5 ft³	¾"	5-9 GPM	1	Call for Pricing
WHR1054	Pro Series	10" x 54"	Black	Catalytic	2.0 ft³	¾"	7-9 GPM	1	Call for Pricing
WHR935-1	Pro Series	9" x 35"	Natural	Catalytic	1.0 ft³	1"	3-4 GPM	1	Call for Pricing
WHR948-1	Pro Series	9" x 48"	Black	Catalytic	1.5 ft³	1"	5-9 GPM	1	Call for Pricing
WHR1054-1	Pro Series	10" x 54"	Black	Catalytic	2.0 ft³	1"	7-9 GPM	1	Call for Pricing
WHR935-CSS	Fleck®	9" x 35"	Natural	Catalytic	1.0 ft³	¾"	3-4 GPM	1	Call for Pricing
WHR948-CSS	Fleck®	9" x 48"	Black	Catalytic	1.5 ft³	¾"	5-9 GPM	1	Call for Pricing
WHR1054-CSS	Fleck®	10" x 54"	Black	Catalytic	2.0 ft³	¾"	7-9 GPM	1	Call for Pricing
WHR1252-CSS	Fleck®	12" x 52"	Black	Catalytic	2.5 ft³	¾"	8-10 GPM	1	Call for Pricing
WHR1354-CSS	Fleck®	13" x 54"	Black	Catalytic	3.0 ft³	¾"	10-13 GPM	1	Call for Pricing
WHR935-CSS-CC	Fleck®	9" x 35"	Natural	Catalytic	1.0 ft³	¾"	3-4 GPM	1	Call for Pricing
WHR948-CSS-CC	Fleck®	9" x 48"	Black	Catalytic	1.5 ft³	¾"	5-9 GPM	1	Call for Pricing
WHR1054-CSS-CC	Fleck®	10" x 54"	Black	Catalytic	2.0 ft³	¾"	7-9 GPM	1	Call for Pricing
WHR1252-CSS-CC	Fleck®	12" x 52"	Black	Catalytic	2.5 ft³	¾"	10-12 GPM	1	Call for Pricing
WHR1354-CSS-CC	Fleck®	13" x 54"	Black	Catalytic	3.0 ft³	¾"	10-13 GPM	1	Call for Pricing

Pro Series
Controls

PENTAIR
FLECK®

ORIGINAL
Catalytic
GAC

JACOBI
CARBONS



H2O Filter Warehouse High Flow Carbon Filters with Fleck® Valve

Part Number	Tank Size	Tank Type	Control Type	Carbon Amount	Flow Rate	Your Price
5800BW-4.0-GAC	16" x 65"	Structural®	Fleck® 5800	4.0 Ft³	16-20 GPM	Call for Pricing
2815BW-4.0-GAC	16" x 65"	Structural®	Fleck® 5800	4.0 Ft³	16-20 GPM	Call for Pricing
2815BW-5.0-GAC	18" x 65"	Structural®	Fleck® 2815	5.0 Ft³	20-25 GPM	Call for Pricing
2815BW-7.0-GAC	21" x 62"	Structural®	Fleck® 2815	7.0 Ft³	28-35 GPM	Call for Pricing
2815BW-9.0-GAC	24" x 72"	Structural®	Fleck® 2815	9.0 Ft³	36-45 GPM	Call for Pricing
2815NXT-5.0-GAC	18" x 65"	Structural®	Fleck® 2815	5.0 Ft³	20-25 GPM	Call for Pricing



H2O Filter Warehouse High Flow Catalytic GAC Carbon Filters with Fleck® Valve

Part Number	Tank Size	Tank Type	Control Type	Carbon Amount	Flow Rate	Your Price
5800BW-4.0-CC	16" x 65"	Structural®	Fleck® 5800	4.0 Ft³	16-20 GPM	Call for Pricing
2815BW-4.0-CC	16" x 65"	Structural®	Fleck® 2815	4.0 Ft³	16-20 GPM	Call for Pricing
2815BW-5.0-CC	18" x 65"	Structural®	Fleck® 2815	5.0 Ft³	20-25 GPM	Call for Pricing
2815BW-7.0-CC	21" x 62"	Structural®	Fleck® 2815	7.0 Ft³	28-35 GPM	Call for Pricing
2815BW-9.0-CC	24" x 72"	Structural®	Fleck® 2815	9.0 Ft³	36-45 GPM	Call for Pricing
2815NXT-GAC-5CC	18" x 65"	Structural®	Fleck® 2815NXT	5.0 Ft³	20-25 GPM	Call for Pricing

FW-5800BW-S2-4LM

FW-2815BW-S2-5LM

FW-2815BW-S2-7LM

FW-2815BW-S2-9LM



Standard 1.5" on 2815 Stainless Steel Valve.



FLECK®





Water Softeners

H2O Filter Warehouse Digital Timer Controlled Softeners with Pro Series PS1-TC Valve

Part Number	Tank Size	Tank Type	Control	Brine Tank Size	Salt Capacity	Resin Crosslink	Capacity (In Grains)	Resin Amount	Your Price
PS1TC-1.0-SR8	9" x 48"	Structural®	PS1-TC (Timer)	14" x 14" x 35"	230 lbs.	8%	32,000	1.0 Ft³	Call for Pricing
PS1TC-1.5-SR8	10" x 54"	Structural®	PS1-TC (Timer)	14" x 14" x 35"	230 lbs.	8%	48,000	1.5 Ft³	Call for Pricing
PS1TC-2.0-SR8	12" x 52"	Structural®	PS1-TC (Timer)	14" x 14" x 35"	230 lbs.	8%	64,000	2.0 Ft³	Call for Pricing
PS1TC-2.5-SR8	13" x 54"	Structural®	PS1-TC (Timer)	14" x 14" x 35"	230 lbs.	8%	80,000	2.5 Ft³	Call for Pricing
PS1TC-3.0-SR8	14" x 65"	Structural®	PS1-TC (Timer)	19" x 35"	385 lbs.	8%	96,000	3.0 Ft³	Call for Pricing
PS1TC-4.0-SR8	16" x 65"	Structural®	PS1-TC (Timer)	19" x 35"	385 lbs.	8%	128,000	4.0 Ft³	Call for Pricing
PS1TC-5.0-SR8	18" x 65"	Structural®	PS1-TC (Timer)	23" x 37"	700 lbs.	8%	160,000	5.0 Ft³	Call for Pricing
PS1TC-7.0-SR8	21" x 62"	Structural®	PS1-TC (Timer)	23" x 37"	700 lbs.	8%	224,000	7.0 Ft³	Call for Pricing

H2O Filter Warehouse Digital Meter Controlled Softeners with Pro Series PS1-EM Valve

Part Number	Tank Size	Tank Type	Control	Brine Tank Size	Salt Capacity	Resin Crosslink	Capacity (In Grains)	Resin Amount	Your Price
PS1EM-1.0-SR8	9" x 48"	Structural®	PS1-EM (Meter)	14" x 14" x 35"	230 lbs.	8%	32,000	1.0 Ft³	Call for Pricing
PS1EM-1.5-SR8	10" x 54"	Structural®	PS1-EM (Meter)	14" x 14" x 35"	230 lbs.	8%	48,000	1.5 Ft³	Call for Pricing
PS1EM-2.0-SR8	12" x 52"	Structural®	PS1-EM (Meter)	14" x 14" x 35"	230 lbs.	8%	64,000	2.0 Ft³	Call for Pricing
PS1EM-2.5-SR8	13" x 54"	Structural®	PS1-EM (Meter)	14" x 14" x 35"	230 lbs.	8%	80,000	2.5 Ft³	Call for Pricing
PS1EM-3.0-SR8	14" x 65"	Structural®	PS1-EM (Meter)	19" x 35"	385 lbs.	8%	96,000	3.0 Ft³	Call for Pricing
PS1EM-4.0-SR8	16" x 65"	Structural®	PS1-EM (Meter)	19" x 35"	385 lbs.	8%	128,000	4.0 Ft³	Call for Pricing
PS1EM-5.0-SR8	18" x 65"	Structural®	PS1-EM (Meter)	23" x 37"	700 lbs.	8%	160,000	5.0 Ft³	Call for Pricing
PS1EM-7.0-SR8	21" x 62"	Structural®	PS1-EM (Meter)	23" x 37"	700 lbs.	8%	224,000	7.0 Ft³	Call for Pricing

H2O Filter Warehouse Digital Meter Controlled Softeners with Pro Series PS1-CS Valve

Part Number	Tank Size	Tank Type	Control	Brine Tank Size	Salt Capacity	Resin Crosslink	Capacity (In Grains)	Resin Amount	Your Price
PS1CS-1.0-SR8	9" x 48"	Structural®	PS1-CS (Meter)	14" x 14" x 35"	230 lbs.	8%	32,000	1.0 Ft³	Call for Pricing
PS1CS-1.5-SR8	10" x 54"	Structural®	PS1-CS (Meter)	14" x 14" x 35"	230 lbs.	8%	48,000	1.5 Ft³	Call for Pricing
PS1CS-2.0-SR8	12" x 52"	Structural®	PS1-CS (Meter)	14" x 14" x 35"	230 lbs.	8%	64,000	2.0 Ft³	Call for Pricing
PS1CS-2.5-SR8	13" x 54"	Structural®	PS1-CS (Meter)	14" x 14" x 35"	230 lbs.	8%	80,000	2.5 Ft³	Call for Pricing
PS1CS-3.0-SR8	14" x 65"	Structural®	PS1-CS (Meter)	19" x 35"	385 lbs.	8%	96,000	3.0 Ft³	Call for Pricing
PS1CS-4.0-SR8	16" x 65"	Structural®	PS1-CS (Meter)	19" x 35"	385 lbs.	8%	128,000	4.0 Ft³	Call for Pricing
PS1CS-5.0-SR8	18" x 65"	Structural®	PS1-CS (Meter)	23" x 37"	700 lbs.	8%	160,000	5.0 Ft³	Call for Pricing
PS1CS-7.0-SR8	21" x 62"	Structural®	PS1-CS (Meter)	23" x 37"	700 lbs.	8%	224,000	7.0 Ft³	Call for Pricing

Softeners include 1" Bypass, Brine Tank with Salt Bridge & Safety Brine Valve. 10% Resin Available, call for pricing.



Bypass Valve

BUILT WITH:

Pro Series Controls



RESINTECH INC.
INNOVATIONS IN ION EXCHANGE



H2O Filter Warehouse Mixed Bed Digital Timer Controlled Softeners w/ Pro Series PS1-TC Valve

Part Number	Tank Size	Tank Type	Control	Brine Tank Size	Resin Crosslink	Capacity (In Grains)	Resin Amount	GAC Amount	Your Price
PS1TC-1.5-MB*	10" x 54"	Structural®	PS1-TC (Timer)	14" x 14" x 35"	8%	16,000	0.5 Ft³	1.0 Ft³	Call for Pricing
PS1TC-2.0-MB*	12" x 52"	Structural®	PS1-TC (Timer)	14" x 14" x 35"	8%	32,000	1.0 Ft³	1.0 Ft³	Call for Pricing
PS1TC-2.5-MB*	13" x 54"	Structural®	PS1-TC (Timer)	14" x 14" x 35"	8%	32,000	1.0 Ft³	1.5 Ft³	Call for Pricing



H2O Filter Warehouse Mixed Bed Digital Meter Controlled Softeners w/ Pro Series PS1-EM Valve

Part Number	Tank Size	Tank Type	Control	Brine Tank Size	Resin Crosslink	Capacity (In Grains)	Resin Amount	GAC Amount	Your Price
PS1EM-1.5-MB*	10" x 54"	Structural®	PS1-EM (Meter)	14" x 14" x 35"	8%	16,000	0.5 Ft³	1.0 Ft³	Call for Pricing
PS1EM-2.0-MB*	12" x 52"	Structural®	PS1-EM (Meter)	14" x 14" x 35"	8%	32,000	1.0 Ft³	1.0 Ft³	Call for Pricing
PS1EM-2.5-MB*	13" x 54"	Structural®	PS1-EM (Meter)	14" x 14" x 35"	8%	32,000	1.0 Ft³	1.5 Ft³	Call for Pricing



H2O Filter Warehouse Mixed Bed Digital Meter Controlled Softeners w/ Pro Series PS1-CS Valve

Part Number	Tank Size	Tank Type	Control	Brine Tank Size	Resin Crosslink	Capacity (In Grains)	Resin Amount	GAC Amount	Your Price
PS1CS-1.5-MB*	10" x 54"	Structural®	PS1-CS (Meter)	14" x 14" x 35"	8%	16,000	0.5 Ft³	1.0 Ft³	Call for Pricing
PS1CS-2.0-MB*	12" x 52"	Structural®	PS1-CS (Meter)	14" x 14" x 35"	8%	32,000	1.0 Ft³	1.0 Ft³	Call for Pricing
PS1CS-2.5-MB*	13" x 54"	Structural®	PS1-CS (Meter)	14" x 14" x 35"	8%	32,000	1.0 Ft³	1.5 Ft³	Call for Pricing

Softeners include 1" Bypass, Brine Tank with Salt Bridge & Safety Brine Valve. 10% Resin Available, call for pricing.
*Tail pieces are sold separately.



Bypass Valve



Systems Built with Catalytic Carbon



BUILT WITH:

Pro Series
Controls



RESINTECH INC.
INNOVATIONS IN ION EXCHANGE

JACOBI
CARBONS





H2O Filter Warehouse Digital Timer Controlled Softeners with Fleck® 5800SXT Valve

Part Number	Tank Size	Tank Type	Control	Brine Tank Size	Resin Crosslink	Capacity (In Grains)	Resin Amount	Your Price
58SXT-1.0-SR8	9" x 48"	Structural@	5800SXT (Timer)	14" x 14" x 35"	8%	32,000	1.0 Ft³	Call for Pricing
58SXT-1.5-SR8	10" x 54"	Structural@	5800SXT (Timer)	14" x 14" x 35"	8%	48,000	1.5 Ft³	Call for Pricing
58SXT-2.0-SR8	12" x 52"	Structural@	5800SXT (Timer)	14" x 14" x 35"	8%	64,000	2.0 Ft³	Call for Pricing
58SXT-2.5-SR8	13" x 54"	Structural@	5800SXT (Timer)	14" x 14" x 35"	8%	80,000	2.5 Ft³	Call for Pricing



H2O Filter Warehouse Digital Meter Controlled Softeners with Fleck® 5800SXM Valve

Part Number	Tank Size	Tank Type	Control	Brine Tank Size	Resin Crosslink	Capacity (In Grains)	Resin Amount	Your Price
58SXM-1.0-SR8	9" x 48"	Structural@	5800SXM (Meter)	14" x 14" x 35"	8%	32,000	1.0 Ft³	Call for Pricing
58SXM-1.5-SR8	10" x 54"	Structural@	5800SXM (Meter)	14" x 14" x 35"	8%	48,000	1.5 Ft³	Call for Pricing
58SXM-2.0-SR8	12" x 52"	Structural@	5800SXM (Meter)	14" x 14" x 35"	8%	64,000	2.0 Ft³	Call for Pricing
58SXM-2.5-SR8	13" x 54"	Structural@	5800SXM (Meter)	14" x 14" x 35"	8%	80,000	2.5 Ft³	Call for Pricing



H2O Filter Warehouse Digital Timer Controlled Softeners with Fleck® 5600SXT Valve

Part Number	Tank Size	Tank Type	Control	Brine Tank Size	Resin Crosslink	Capacity (In Grains)	Resin Amount	Your Price
56SXT-1.0-SR8	9" x 48"	Structural@	5600SXT (Timer)	14" x 14" x 35"	8%	32,000	1.0 Ft³	Call for Pricing
56SXT-1.5-SR8	10" x 54"	Structural@	5600SXT (Timer)	14" x 14" x 35"	8%	48,000	1.5 Ft³	Call for Pricing
56SXT-2.0-SR8	12" x 52"	Structural@	5600SXT (Timer)	14" x 14" x 35"	8%	64,000	2.0 Ft³	Call for Pricing
56SXT-2.5-SR8	13" x 54"	Structural@	5600SXT (Timer)	14" x 14" x 35"	8%	80,000	2.5 Ft³	Call for Pricing



H2O Filter Warehouse Digital Meter Controlled Softeners with Fleck® 5600SXM Valve

Part Number	Tank Size	Tank Type	Control	Brine Tank Size	Resin Crosslink	Capacity (In Grains)	Resin Amount	Your Price
56SXM-1.0-SR8	9" x 48"	Structural@	5600SXM (Meter)	14" x 14" x 35"	8%	32,000	1.0 Ft³	Call for Pricing
56SXM-1.5-SR8	10" x 54"	Structural@	5600SXM (Meter)	14" x 14" x 35"	8%	48,000	1.5 Ft³	Call for Pricing
56SXM-2.0-SR8	12" x 52"	Structural@	5600SXM (Meter)	14" x 14" x 35"	8%	64,000	2.0 Ft³	Call for Pricing
56SXM-2.5-SR8	13" x 54"	Structural@	5600SXM (Meter)	14" x 14" x 35"	8%	80,000	2.5 Ft³	Call for Pricing
56SXM-3.0-SR8	14" x 65"	Structural@	5600SXM (Meter)	14" x 14" x 35"	8%	96,000	3.0 Ft³	Call for Pricing

Softeners include ¾" Stainless Steel Bypass, Brine Tank with Salt Bridge & Safety Brine Valve.
10% Resin Available, call for pricing.



BUILT WITH:



FLECK®





H2O Filter Warehouse Mixed Bed Digital Timer Controlled Softeners with Fleck® 5800SXT Valve

Part Number	Tank Size	Tank Type	Control	Brine Tank Size	Resin Crosslink	Capacity (In Grains)	Resin Amount	GAC Amount	Your Price
58SXT-1.5-MB	10" x 54"	Structural®	5800SXT (Timer)	14" x 14" x 35"	8%	16,000	0.5 Ft³	1.0 Ft³	Call for Pricing
58SXT-2.0-MB	12" x 52"	Structural®	5800SXT (Timer)	14" x 14" x 35"	8%	32,000	1.0 Ft³	1.0 Ft³	Call for Pricing
58SXT-2.5-MB	13" x 54"	Structural®	5800SXT (Timer)	14" x 14" x 35"	8%	32,000	1.0 Ft³	1.5 Ft³	Call for Pricing



H2O Filter Warehouse Mixed Bed Digital Meter Controlled Softeners with Fleck® 5800SXM Valve

Part Number	Tank Size	Tank Type	Control	Brine Tank Size	Resin Crosslink	Capacity (In Grains)	Resin Amount	GAC Amount	Your Price
58SXM-1.5-MB	10" x 54"	Structural®	5800SXM (Meter)	14" x 14" x 35"	8%	16,000	0.5 Ft³	1.0 Ft³	Call for Pricing
58SXM-2.0-MB	12" x 52"	Structural®	5800SXM (Meter)	14" x 14" x 35"	8%	32,000	1.0 Ft³	1.0 Ft³	Call for Pricing
58SXM-2.5-MB	13" x 54"	Structural®	5800SXM (Meter)	14" x 14" x 35"	8%	32,000	1.0 Ft³	1.5 Ft³	Call for Pricing

Softeners include ¾" Stainless Steel Bypass, Brine Tank w Salt Bridge & Safety Brine Valve.
10% Resin Available, call for pricing.



H2O Filter Warehouse Mixed Bed Digital Timer Controlled Softeners with Fleck® 5600SXT Valve

Part Number	Tank Size	Tank Type	Control	Brine Tank Size	Resin Crosslink	Capacity (In Grains)	Resin Amount	GAC Amount	Your Price
56SXT-1.5-MB	10" x 54"	Structural®	56SXT/16 (Timer)	14" x 14" x 35"	8%	16,000	0.5 Ft³	1.0 Ft³	Call for Pricing
56SXT-2.0-MB	12" x 52"	Structural®	56SXT/16 (Timer)	14" x 14" x 35"	8%	32,000	1.0 Ft³	1.0 Ft³	Call for Pricing
56SXT-2.5-MB	13" x 54"	Structural®	56SXT/16 (Timer)	14" x 14" x 35"	8%	32,000	1.0 Ft³	1.5 Ft³	Call for Pricing



H2O Filter Warehouse Mixed Bed Digital Meter Controlled Softeners with Fleck® 5600SXM Valve

Part Number	Tank Size	Tank Type	Control	Brine Tank Size	Resin Crosslink	Capacity (In Grains)	Resin Amount	GAC Amount	Your Price
56SXM-1.5-MB	10" x 54"	Structural®	56SXM/16 (Meter)	14" x 14" x 35"	8%	16,000	0.5 Ft³	1.0 Ft³	Call for Pricing
56SXM-2.0-MB	12" x 52"	Structural®	56SXM/16 (Meter)	14" x 14" x 35"	8%	32,000	1.0 Ft³	1.0 Ft³	Call for Pricing
56SXM-2.5-MB	13" x 54"	Structural®	56SXM/16 (Meter)	14" x 14" x 35"	8%	32,000	1.0 Ft³	1.5 Ft³	Call for Pricing

Fleck 5800
SXT/SXM



Stainless Steel
Bypass Valve

Systems Built with
Catalytic Carbon



BUILT WITH:



FLECK®



H2O Filter Warehouse Twin Softeners



Part Number	Tank Size	Tank Type	Control	Brine Tank Size	Salt Capacity	Resin Crosslink	Capacity (In Grains)	Resin Amount	Your Price
9100SXM-1.5-SR8	10" x 54"	Structural@	9100M	19" x 19" x 35"	385 lbs.	8%	2 @ 48,000	3.0 Ft³	Call for Pricing
9100SXM-2.0-SR8	12" x 52"	Structural@	9100M	19" x 19" x 35"	385 lbs.	8%	2 @ 64,000	4.0 Ft³	Call for Pricing
9100SXM-2.5-SR8	13" x 54"	Structural@	9100M	19" x 19" x 35"	385 lbs.	8%	2 @ 80,000	5.0 Ft³	Call for Pricing
9100SXM-3.0-SR8	14" x 65"	Structural@	9100M	19" x 19" x 35"	385 lbs.	8%	2 @ 96,000	6.0 Ft³	Call for Pricing
9100SXM-4.0-SR8	16" x 65"	Structural@	9100M	19" x 19" x 35"	385 lbs.	8%	2 @ 128,000	8.0 Ft³	Call for Pricing

Softeners include ¾" Stainless Steel Bypass, Brine Tank w Salt Bridge & Safety Brine Valve.
10% Resin Available, call for pricing.



Fleck 9100M Metered Valve

Stainless Steel Bypass Valve



BUILT WITH:



FLECK®

Features:

Light Commercial/Residential twin tank system composed of a fiber-reinforced polymer valve body for superior strength and durability, non-corrosion and UV-resistance.

- ◆ Continuous service flow rate of 20 GPM with a backwash of 8.5 GPM
- ◆ Regenerates immediately when needed for continuous soft water
- ◆ Soft water regeneration for optimum operating efficiency and minimum maintenance



Iron Filters with Filox® Media

Part Number	Tank Size	Tank Type	Control Type	Drain Line Flow Control	Flow Rate	Media Amount	Your Price
58SXT-1.0-FX	9" x 48"	Structural® Polyglass™	Fleck® 5800	8 GPM DLFC	4-6 GPM	1.0 Ft³	Call for Pricing
58SXT-1.5-FX	10" x 54"	Structural® Polyglass™	Fleck® 5800	10 GPM DLFC	6-8 GPM	1.5 Ft³	Call for Pricing
58SXT-2.0-FX	12" x 52"	Structural® Polyglass™	Fleck® 5800	15 GPM DLFC	8-10 GPM	2.0 Ft³	Call for Pricing
58SXT-2.5-FX	13" x 54"	Structural® Polyglass™	Fleck® 5800	15 GPM DLFC	10-12 GPM	2.5 Ft³	Call for Pricing
PS1BW-1.0-FX	9" x 48"	Structural® Polyglass™	Pro Series PS1-BW	8 GPM DLFC	4-6 GPM	1.0 Ft³	Call for Pricing
PS1BW-1.5-FX	10" x 54"	Structural® Polyglass™	Pro Series PS1-BW	10 GPM DLFC	6-8 GPM	1.5 Ft³	Call for Pricing
PS1BW-2.0-FX	12" x 52"	Structural® Polyglass™	Pro Series PS1-BW	15 GPM DLFC	8-10 GPM	2.0 Ft³	Call for Pricing
PS1BW-2.5-FX	13" x 54"	Structural® Polyglass™	Pro Series PS1-BW	15 GPM DLFC	10-16 GPM	2.5 Ft³	Call for Pricing
PS1EM-1.0-FX	9" x 48"	Structural® Polyglass™	Pro Series PS1-EM	8 GPM DLFC	4-6 GPM	1.0 Ft³	Call for Pricing
PS1EM-1.5-FX	10" x 54"	Structural® Polyglass™	Pro Series PS1-EM	10 GPM DLFC	6-8 GPM	1.5 Ft³	Call for Pricing

Call for quote on larger systems.
Tail pieces are sold separately.

Iron, Hydrogen Sulfide & Manganese Removal Systems

Features:

- ◆ Up to 5 ppm Iron Removal
- ◆ Up to 5 ppm Hydrogen Sulfide (Sulfur) Removal
- ◆ Up to 3 ppm Manganese Removal
- ◆ No Chemicals Needed
- ◆ Backwashes Clean with Water

MEDIA



Systems Includes:
Stainless Steel Bypass



Backwashing Sediment Filters with Micro-Z® Media

Part Number	Tank Size	Tank Type	Control Type	Drain Line Flow Control	Flow Rate	Media Amount	Your Price
58SXT-1.0-MZ	9" x 48"	Structural® Polyglass™	Fleck® 5800	7 GPM DLFC	4-7 GPM	1.0 Ft³	Call for Pricing
58SXT-1.5-MZ	10" x 54"	Structural® Polyglass™	Fleck® 5800	8 GPM DLFC	6-9 GPM	1.5 Ft³	Call for Pricing
58SXT-2.0-MZ	12" x 52"	Structural® Polyglass™	Fleck® 5800	10 GPM DLFC	8-14 GPM	2.0 Ft³	Call for Pricing
58SXT-2.5-MZ	13" x 54"	Structural® Polyglass™	Fleck® 5800	15 GPM DLFC	10-16 GPM	2.5 Ft³	Call for Pricing
58SXT-3.0-MZ	14" x 65"	Structural® Polyglass™	Fleck® 5800	15 GPM DLFC	16-28 GPM	3.0 Ft³	Call for Pricing
PS1EM-1.0-MZ	9" x 48"	Structural® Polyglass™	Pro Series PS1-EM	7 GPM DLFC	4-7 GPM	1.0 Ft³	Call for Pricing
PS1BW-1.0-MZ	9" x 48"	Structural® Polyglass™	Pro Series PS1-BW	7 GPM DLFC	4-7 GPM	1.0 Ft³	Call for Pricing
PS1BW-1.5-MZ	10" x 54"	Structural® Polyglass™	Pro Series PS1-BW	8 GPM DLFC	6-9 GPM	1.5 Ft³	Call for Pricing
PS1BW-2.0-MZ	12" x 52"	Structural® Polyglass™	Pro Series PS1-BW	10 GPM DLFC	8-14 GPM	2.0 Ft³	Call for Pricing
PS1BW-2.5-MZ	13" x 54"	Structural® Polyglass™	Pro Series PS1-BW	15 GPM DLFC	10-16 GPM	2.5 Ft³	Call for Pricing

Call for quote on larger systems.
Tail pieces are sold separately.

Sediment, Rust, Silt & Turbidity Removal Systems

Features:

- ◆ 5-10 Micron Sediment Filtration
- ◆ Uses 50% Less Water than Sand Filters
- ◆ No Chemicals Needed
- ◆ Backwashes Clean with Water

MEDIA



Systems Includes:
Stainless Steel Bypass





Acid Neutralizing Filters

Part Number	Tank Size	Tank Type	Control Type	Flow Rate	Media Amount	Your Price
FT-1.0-CSCX-UF*	10" x 54"	Structural@ Polyglass™ Dome Hole	N/A	8-10 GPM	1.0 Ft³	Call for Pricing
FT-2.0-CSCX-UF*	13" x 54"	Structural@ Polyglass™ Dome Hole	N/A	16-20 GPM	2.0 Ft³	Call for Pricing
58SXT-1.0-CSCX**	10" x 54"	Structural@ Polyglass™ Dome Hole	Fleck@ 5800	8-10 GPM	1.0 Ft³	Call for Pricing
58SXT-2.0-CSCX**	13" x 54"	Structural@ Polyglass™ Dome Hole	Fleck@ 5800	16-20 GPM	2.0 Ft³	Call for Pricing
PS1BW-1.0-CSCX*	10" x 54"	Structural@ Polyglass™ Dome Hole	Pro Series PS1-BW	4-6 GPM	1.0 Ft³	Call for Pricing
PS1BW-2.0-CSCX*	13" x 54"	Structural@ Polyglass™ Dome Hole	Pro Series PS1-BW	8-10 GPM	2.0 Ft³	Call for Pricing

*Systems include noryl bypass. Tail pieces are sold separately.
 **Systems with Fleck Controls include Stainless Steel Bypass w/ 1" FNPT ports.

Acid Neutralizing Systems

Features:

- ◆ Corrects Low pH
- ◆ Stops Copper Corrosion & Blue/Green Staining
- ◆ 1 Ft³ Systems include:
 - (1) 50 lb. bag of Calcite and
 - (1) 50 lb. bag of FloMag
- ◆ 2 Ft³ Systems include:
 - (2) 50 lb. bags of Calcite and
 - (2) 50 lb. bags of FloMag

MEDIA





Reverse Osmosis Systems

4 Stage RO w/ 50, 60 or 100 GPD TFC Membrane*

Part Number	Description	Membrane	Ship Wgt	Your Price
USRO4-50-JG	4 Stage, Faucet, John Guest Quick-Connect Fittings, Valves and Tubing,	50 GPD	23 lbs.	Call for Pricing
USRO4-60-JG	10µ Coconut Shell Block & GAC Post Filter, 3/8" Fittings & Tubing After Bladder	60 GPD	23 lbs.	Call for Pricing
USRO4-100-JG		100 GPD	23 lbs.	Call for Pricing
USRO4-50-JG-NF	4 Stage, No Faucet , John Guest Quick-Connect Fittings, Valves and Tubing,	50 GPD	22 lbs.	Call for Pricing
USRO4-60-JG-NF	10µ Coconut Shell Block & GAC Post Filter, 3/8" Fittings & Tubing After Bladder	60 GPD	22 lbs.	Call for Pricing
USRO4-100-JG-NF		100 GPD	22 lbs.	Call for Pricing
USRO4-50-JG-NT	4 Stage, No Bladder Tank , Faucet, John Guest Quick-Connect Fittings, Valves and Tubing,	50 GPD	15 lbs.	Call for Pricing
USRO4-60-JG-NT	10µ Coconut Shell Block & GAC Post Filter, 3/8" Fittings & Tubing	60 GPD	15 lbs.	Call for Pricing
USRO4-100-JG-NT		100 GPD	15 lbs.	Call for Pricing
USRO4-50-JG-NF-NT	4 Stage, No Faucet or Tank , John Guest Quick-Connect Fittings, Valves and Tubing,	50 GPD	14 lbs.	Call for Pricing
USRO4-60-JG-NF-NT	10µ Coconut Shell Block & GAC Post Filter, 3/8" Fittings & Tubing	60 GPD	14 lbs.	Call for Pricing
USRO4-100-JG-NF-NT		100 GPD	14 lbs.	Call for Pricing



5 Stage RO w/ 50, 60 or 100 GPD TFC Membrane*

Part Number	Description	Membrane	Ship Wgt	Your Price
USRO5-50-JG	5 Stage, Faucet, John Guest Quick-Connect Fittings, Valves and Tubing,	50 GPD	26 lbs.	Call for Pricing
USRO5-60-JG	(2) 10µ Coconut Shell Blocks & GAC Post Filter, 3/8" Fittings & Tubing After Bladder	60 GPD	26 lbs.	Call for Pricing
USRO5-100-JG		100 GPD	26 lbs.	Call for Pricing
USRO5-50-JG-NF	5 Stage, No Faucet , John Guest Quick-Connect Fittings, Valves and Tubing,	50 GPD	25 lbs.	Call for Pricing
USRO5-60-JG-NF	(2) 10µ Coconut Shell Block & GAC Post Filter, 3/8" Fittings & Tubing After Bladder	60 GPD	25 lbs.	Call for Pricing
USRO5-100-JG-NF		100 GPD	25 lbs.	Call for Pricing
USRO5-50-JG-NT	5 Stage, No Bladder Tank, Faucet , John Guest Quick-Connect Fittings, Valves and Tubing,	50 GPD	18 lbs.	Call for Pricing
USRO5-60-JG-NT	(2) 10µ Coconut Shell Block & GAC Post Filter, 3/8" Fittings & Tubing	60 GPD	18 lbs.	Call for Pricing
USRO5-100-JG-NT		100 GPD	18 lbs.	Call for Pricing
USRO5-50-JG-NF-NT	5 Stage, No Faucet or Tank , John Guest Quick-Connect Fittings, Valves and Tubing,	50 GPD	17 lbs.	Call for Pricing
USRO5-60-JG-NF-NT	(2) 10µ Coconut Shell Block & GAC Post Filter, 3/8" Fittings & Tubing	60 GPD	17 lbs.	Call for Pricing
USRO5-100-JG-NF-NT		100 GPD	17 lbs.	Call for Pricing



NOW BUILT WITH NSF PENTAIR HOUSINGS

Each Unit is Pressure Tested

Assembled in the USA

Sales Brochure Available

- ◆ John Guest Quick-Connect Fittings & Tubing
- ◆ John Guest Angle Stop Valve & Tank Valve
- ◆ All Systems have 3/8" Fittings & Tubing After Bladder

- ◆ 50 & 100 GPD Models Include Pentair Membrane
- ◆ 60 GPD Models Include CSM Membrane
- ◆ Better Packaging Than Most RO's



4 Stage RO w/ 50 or 100 GPD TFC High Recovery Membrane*



Part Number	Description	Membrane	Ship Wgt	Your Price
USRO4-50HR	4 Stage, Faucet, John Guest Quick-Connect Fittings, Valves and Tubing,	50 GPD	23 lbs.	Call for Pricing
USRO4-100HR	10µ Coconut Shell Block & GAC Post Filter, 3/8" Fittings & Tubing After Bladder	100 GPD	23 lbs.	Call for Pricing
USRO4-50HR-NF	4 Stage, No Faucet , John Guest Quick-Connect Fittings, Valves and Tubing,	50 GPD	22 lbs.	Call for Pricing
USRO4-100HR-NF	10µ Coconut Shell Block & GAC Post Filter, 3/8" Fittings & Tubing After Bladder	100 GPD	22 lbs.	Call for Pricing
USRO4-50HR-NT	4 Stage, No Bladder Tank , Faucet, John Guest Quick-Connect Fittings, Valves and Tubing,	50 GPD	15 lbs.	Call for Pricing
USRO4-100HR-NT	10µ Coconut Shell Block & GAC Post Filter, 3/8" Fittings & Tubing	100 GPD	15 lbs.	Call for Pricing
USRO4-50HR-NF-NT	4 Stage, No Faucet or Tank , John Guest Quick-Connect Fittings, Valves and Tubing,	50 GPD	14 lbs.	Call for Pricing
USRO4-100HR-NF-NT	10µ Coconut Shell Block & GAC Post Filter, 3/8" Fittings & Tubing	100 GPD	14 lbs.	Call for Pricing

5 Stage RO w/ 50 or 100 GPD TFC High Recovery Membrane*



Part Number	Description	Membrane	Ship Wgt	Your Price
USRO5-50HR	5 Stage, Faucet, John Guest Quick-Connect Fittings, Valves and Tubing,	50 GPD	26 lbs.	Call for Pricing
USRO5-100HR	(2) 10µ Coconut Shell Blocks & GAC Post Filter, 3/8" Fittings & Tubing After Bladder	100 GPD	26 lbs.	Call for Pricing
USRO5-50HR-NF	5 Stage, No Faucet , John Guest Quick-Connect Fittings, Valves and Tubing,	50 GPD	25 lbs.	Call for Pricing
USRO5-100HR-NF	(2) 10µ Coconut Shell Block & GAC Post Filter, 3/8" Fittings & Tubing After Bladder	100 GPD	25 lbs.	Call for Pricing
USRO5-50HR-NT	5 Stage, No Bladder Tank , Faucet, John Guest Quick-Connect Fittings, Valves and Tubing,	50 GPD	18 lbs.	Call for Pricing
USRO5-100HR-NT	(2) 10µ Coconut Shell Block & GAC Post Filter, 3/8" Fittings & Tubing	100 GPD	18 lbs.	Call for Pricing
USRO5-50HR-NF-NT	5 Stage, No Faucet or Tank , John Guest Quick-Connect Fittings, Valves and Tubing,	50 GPD	17 lbs.	Call for Pricing
USRO5-100HR-NF-NT	(2) 10µ Coconut Shell Block & GAC Post Filter, 3/8" Fittings & Tubing	100 GPD	17 lbs.	Call for Pricing

*Systems include: 3/8" John Guest Angle Stop Valve, Luxury Ceramic Disk, Lead Free Faucet with Chrome Finish, Drain Saddle & Housing Wrench, 3.2 Gallon Bladder Tank & Shut-Off Valve, Automatic Shut-Off Valve, Faucet Connector, Check Valve, Drain Flow Control, NSF Certified John Guest Fittings & Tubing, Installation Diagrams with Written Installation Instructions.



Assembled in the USA

- ◆ John Guest Quick-Connect Fittings & Tubing
- ◆ John Guest Angle Stop Valve & Tank Valve
- ◆ All Systems have 3/8" Fittings & Tubing After Bladder
- ◆ 50 & 100 GPD Models Include Pentair Membrane
- ◆ 60 GPD Models Include CSM Membrane
- ◆ Better Packaging Than Most RO's



Pentek® Drinking Water Systems

Part Number	Former Part Number	Description	Case Wgt	Stock	Your Price
158839*	F2000-B2B	2 Stage VOC, Lead, Cyst and Parasite System	6.8 lbs.	NS	Call for Pricing
158840*	F3000-B2B	3 Stage Sediment, VOC, Lead, Cyst and Parasite System	8.6 lbs.	NS	Call for Pricing

*Pentair's internet policy prohibits advertising the Freshpoint drinking water system and cartridge pricing online to the general public.

F2000

F3000



GRO-350

GRO-475

GRO-575



Pentek® FreshPoint RO Systems with GRO High Efficiency Membrane



Part Number	Former Part Number	Description	Case Qty	Your Price
161110*	GRO-350B	3 Stage, 50 GPD System	NS	Call for Pricing
161111*	GRO-475B	4 Stage, 75 GPD System	NS	Call for Pricing
161114*	GRO-475BP	4 Stage, 75 GPD System w/ Booster Pump	NS	Call for Pricing
161112*	GRO-575B	5 Stage, 75 GPD System	NS	Call for Pricing

*Pentair's internet policy prohibits advertising the Freshpoint reverse osmosis system and cartridge pricing online to the general public.

Premium Encapsulated Cartridge Systems from Pentair

See Page 20 for Replacement Cartridges.

- ◆ Each Cartridge Head has Built-in Shutoff
- ◆ Cartridges Move Forward when Removed
- ◆ No Twisting or Floor Clearance Needed
- ◆ Extremely Easy to Change and Maintain

GRO Systems Include Installation Kit, Air-Gap Faucet & Bladder Tank.
Monitored Systems feature an Internal TDS Meter.
NSF 42, 58 & CSA B483.1 Certified.

Pentek® Lead Filtration System



Part Number	Description	Your Price
160410	Pentek, LR-BB50, 20 Pb Heavy Duty Lead Filtration System	Call for Pricing



Hydrotech® Hydrotech® Reverse Osmosis Systems



Aqua Flo Quick-Change Reverse Osmosis System

Part Number	Description	Your Price
1340302-60	QCRO4V-50 – 50 GPD Quick-Change Reverse Osmosis System w/ Air Gap Faucet & Tank	Call for Pricing
41407001	Quick-Change 5µ Sediment Cartridge	Call for Pricing
41407002	Quick-Change 5µ Carbon Block Cartridge	Call for Pricing
41407003	Quick-Change 50 GPD Reverse Osmosis Membrane	Call for Pricing
41407004	Quick Change GAC Cartridge	Call for Pricing
41407007	Quick Change pH Booster Cartridge	Call for Pricing

AQUA FLO QUICK-CHANGE 50 GPD DRINKING WATER SYSTEM

Features Include:

- ◆ High Quality Reverse Osmosis Membrane
- ◆ 50 Gallons Output per Day
- ◆ Sediment Pre-Filtration
- ◆ Pre & Post Carbon Block Filtration
- ◆ ¼" Quick-Connect Fittings
- ◆ Color Coded Tubing for Ease of Installation
- ◆ Chrome Faucet
- ◆ Storage Tank



HYDROTECH 1240 SERIES



Hydrotech® 4-Stage Reverse Osmosis Systems

Part Number	Model Number	Description	Ship Wgt	Your Price
1240201-00	4VTFC25G	4-Stage, 25 GPD – 4 Gallon Bladder Tank & Air Gap Faucet	22 lbs.	Call for Pricing
1240202-00	4VTFC50G	4-Stage, 50 GPD – 4 Gallon Bladder Tank & Air Gap Faucet	22 lbs.	Call for Pricing

See Hydrotech Membranes on Page 24.

Hydrotech® Carbon & Sediment Cartridges

Part Number	Model Number	Description	Case Qty	Your Price
41400008	S-FS-02	String Wound Sediment Prefilter Cartridge	50	Call for Pricing
41400009	S-FS-19	Carbon Block Pre- and Post-Filter Cartridge	50	Call for Pricing



Watts® Kwik-Change System Kits

Watts® Kwik-Change Replacement Cartridges



Part Number	Description	Your Price
WQCSC10	10" 5µ Sediment Cartridge	Call for Pricing
WQCCC10	10" 5µ Carbon Block Cartridge	Call for Pricing
WQCHFC10	10" Hollow Fiber Membrane	Call for Pricing
WQCSC11	11" 5µ Sediment Cartridge	Call for Pricing
WQCCG11	11" 5µ Carbon Block Cartridge	Call for Pricing
WQCM11-50	11" 50 GPD Membrane	Call for Pricing
WQCGAC11	11" GAC Post Filter Cartridge	Call for Pricing
WQCHFC11	11" Hollow Fiber Membrane	Call for Pricing
WQCSC13	13" 5µ Sediment Cartridge	Call for Pricing
WQCCC13	13" 5µ Carbon Block Cartridge	Call for Pricing
WQCM13-100	13" 100 GPD Membrane	Call for Pricing
WQCGAC13	13" GAC Post Filter Cartridge	Call for Pricing
WQCHFC13	13" Hollow Fiber Membrane	Call for Pricing





H2O International Sealed Under Sink Filters

3 Year Pro-Rata Warranty



Part Number	Description	Chlorine Capacity	Case Qty	Case Wgt	Your Price
H2O-US4-13*	Inline 5-Stage Under Sink Filter (Replaces NSA 100 Models)	25,000 gal.	3/4"	6 lbs.	Call for Pricing
H2O-US4	Deluxe 5-Stage Under Sink Filter w/ Faucet	35,000 gal.	3/8"	6 lbs.	Call for Pricing
H2O-US4-I*	Inline Deluxe 5-Stage Under Sink Filter	35,000 gal.	3/8"	6 lbs.	Call for Pricing
H2O-US3	5-Stage Under Sink Filter w/ Faucet	25,000 gal.	3/8"	6 lbs.	Call for Pricing
H2O-US3-I	Inline 5-Stage Under Sink Filter	25,000 gal.	3/8"	6 lbs.	Call for Pricing
H2O-US3-I-PRV*	Inline 5-Stage Under Sink Filter w/ Pressure Reducing Valve	25,000 gal.	3/8"	6 lbs.	Call for Pricing

*50 PSI Pressure Reducing Valve, 3/8" Quick-Connect included with these models

US4-13 DIAGRAM

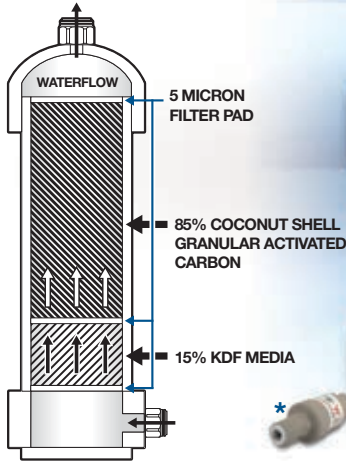

H2O-US4-13

H2O-US4

H2O-US4-I

H2O-US3

H2O-US3-I



H2O-CT-4

H2O-CT

H2O-RC



H2O International Countertop & Icemaker Filters



Part Number	Description	Case Qty	Your Price
H2O-CT-4	5-Stage Counter Top Filter, Includes Diverter & Tubing	12	Call for Pricing
H2O-CT	5-Stage Counter Top Filter, Includes Diverter & Tubing	12	Call for Pricing
H2O-RC	Inline GAC/KDF Icemaker Filter with Quick Connect 1/4" Fittings, Includes Clip	18	Call for Pricing

SH-CPG-5**SH-WH-5****SHH-CP-IL****FM-SHWR-MDF55**

Shower Heads & Filters

Shower Head with 5 Unique Spray Patterns & Replaceable Chlorine Filter Cartridge

Part Number	Description	Inner Case Qty	Case Qty	Your Price
SH-CPG-5	5-Spray Shower Head – KDF 55 media – Chrome Finish	8	16	Call for Pricing
SH-WH-5	5-Spray Shower Head – KDF 55 media – White Finish	8	16	Call for Pricing

Shower Head with Single Spray & Replaceable Chlorine Filter Cartridge

Part Number	Description	Inner Case Qty	Case Qty	Your Price
SH-FILTER	KDF 55 Replacement Filter for SH-CP-1 & SH-WH-1, SH-CPG-5, SH-WH-5 & SH-SN-5	8	32	Call for Pricing

Hand Held Shower Massager with 8 Unique Spray Patterns, Inline Filter & Replacement Cartridge

Part Number	Description	Inner Case Qty	Case Qty	Your Price
SHH-CP-IL	Add-On – KDF 55 Inline Filter – Chrome Finish (for use w/ H2OS-HHELD)	6	36	Call for Pricing
IL-FILTER	Replacement Filter for SHH-IL-CP & SHH-SN-IL	6	36	Call for Pricing

Watts/Flowmatic Dial-A-Date Shower Filter with 100% KDF 55 Media

Part Number	Description	Your Price
FM-SHWR-KDF55	Watts Dial-A-Date Shower Filter – White Box	Call for Pricing





H2O Filter Warehouse Under Sink Systems



1/4" Point-of-Use Filtration Systems (With Faucet)

Part Number	Stages	Description	Case Qty	Case Wgt	Your Price
UCF-01-JG	1	Includes JG Quick-Connect Fittings, (2) Push-In Elbows, Angle Stop Valve, JG Tubing,	4		Call for Pricing
UCF-02-JG	2	Housing Wrench and Bracket, No Cartridges, Non-Branded	4	32.0 lbs.	Call for Pricing
UCF-03-JG	3		4	34.5 lbs.	Call for Pricing



1/4" Point-of-Use Filtration Systems (Without Faucet)

Part Number	Stages	Description	Case Qty	Case Wgt	Your Price
UCF-01-14-JG	1	Includes JG Quick-Connect Fittings, (2) Push-In Elbows, Angle Stop Valve, JG Tubing,	4		Call for Pricing
UCF-02-14-JG	2	Housing Wrench and Bracket, No Cartridges, Non-Branded	4	32.0 lbs.	Call for Pricing
UCF-03-14-JG	3		4	34.5 lbs.	Call for Pricing



3/8" Point-of-Use Filtration Systems (Without Faucet)

Part Number	Stages	Description	Case Qty	Case Wgt	Your Price
UCF-01-38-JG	1	Includes JG Quick-Connect Fittings, (2) 3/8" Elbows, (2) Push-In Elbows, JG Tubing,	4		Call for Pricing
UCF-02-38-JG	2	Housing Wrench and Bracket, No Cartridges or Faucet, Non-Branded	4	32.0 lbs.	Call for Pricing
UCF-03-38-JG	3		4	34.5 lbs.	Call for Pricing

UCF-02-JG DUAL-STAGE

UCF-03-JG TRIPLE-STAGE

SYSTEMS INCLUDE THESE ACCESSORIES



💧 Design Your Own Systems 💧 Cartridges Sold Separately



Gravity Filters

Part Number	Description	Your Price
W9361138	Stainless Steel Gravity Filter w/ (2) 7" Ultra Sterasyl Candles, 8.5 L	Call for Pricing
W9361136	Stainless Steel Gravity Filter w/ (2) 7" Ultra Sterasyl Candles, 6.0 L	Call for Pricing

Doulton® Systems



Part Number	Description	Your Price
W9381000	Doulton® Whole House Ceramic Bacteria Removal at 4-5 GPM, Used with 10" Big Blue/Full-Flow Style Housings	Call for Pricing
W9330229	Doulton® QT Under Counter System w/ UltraCarb Candle	Call for Pricing

CUP DISPENSERS

W9381000
DOULTON® RIO 9000
WHOLE HOUSE

W9330229
DOULTON®
UNDER SINK



Point of Use (POU) Water Cooler Accessories



Cup Holders

Part Number	Description	Your Price
1011721	Water Cup Dispenser (Clear Tube/Almond Head)	Call for Pricing
1011905	Water Cup Dispenser (Clear Tube/Black Head)	Call for Pricing





Viqua® Ultraviolet Systems

See Page 64 for Stainless Steel Connectors and 3/4" Stainless Steel Nipples.



Viqua® Standard Series UV Systems (Powered by Sterilight)

Part Number	Dose (30mJ/cm ²)	Length	Diameter	Inlet/Outlet	Ship Wgt	Stock	Your Price
VH150	5.0 GPM	14.0"	3.5"	3/4" FPT & 1" MPT	8 lbs.	S	Call for Pricing
VH200	9.0 GPM	17.75"	3.5"	3/4" FPT & 1" MPT	12 lbs.	S	Call for Pricing
VH410	18.0 GPM	23.5"	3.5"	3/4" FPT & 1" MPT	17 lbs.	S	Call for Pricing
VP600	24.0 GPM	30.6"	3.5"	1" MPT	19 lbs.	S	Call for Pricing
VP950	46.0 GPM	45.0"	3.5"	1 1/2" MPT	29 lbs.	S	Call for Pricing

Viqua Standard Systems include 304 Stainless Steel UV Reactor, Safety-Loc™ Connector, End of Lamp Life Timer

VH150

VH200

VH410

VP600

VP950



Viqua® Plus Series UV Systems (Powered by Sterilight)

Part Number	Dose (30mJ/cm ²)	Length	Diameter	Inlet/Outlet	Ship Wgt	Stock	Your Price
VH410M	18.0 GPM	23.5"	3.5"	3/4" FPT & 1" MPT	17 lbs.	S	Call for Pricing
VP600M	24.0 GPM	30.6"	3.5"	1" MPT	19 lbs.	NS	Call for Pricing
VP950M	46.0 GPM	45.0"	3.5"	1 1/2" MPT	29 lbs.	NS	Call for Pricing

Viqua Standard Systems include 304 Stainless Steel UV Reactor, Safety-Loc™ Connector, End of Lamp Life Timer, UV Intensity Sensor

VH410M

VP600M

VP950M

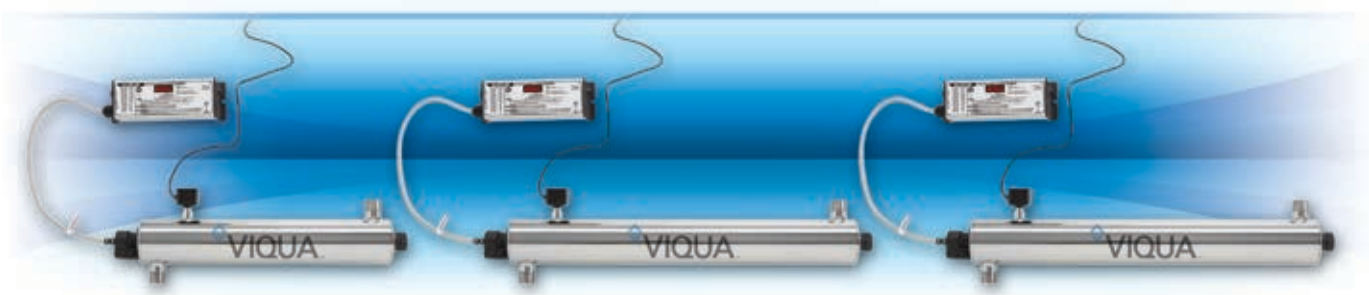

Viqua® Integrated Home UV Systems (Powered by Sterilight)

Part Number	Description	Ship Wgt	Stock	Your Price
VH200-F10	10" Heavy Duty Filter Housing & VH200, 9 GPM UV System	26 lbs.	S	Call for Pricing
VH410-F20	20" Heavy Duty Filter Housing & VH410, 18 GPM UV System	32 lbs.	S	Call for Pricing

Viqua Integrated Systems include 304 Stainless Steel UV Reactor, Safety-Loc™ Connector, End of Lamp Life Timer

VH200-F10

VH410-F20

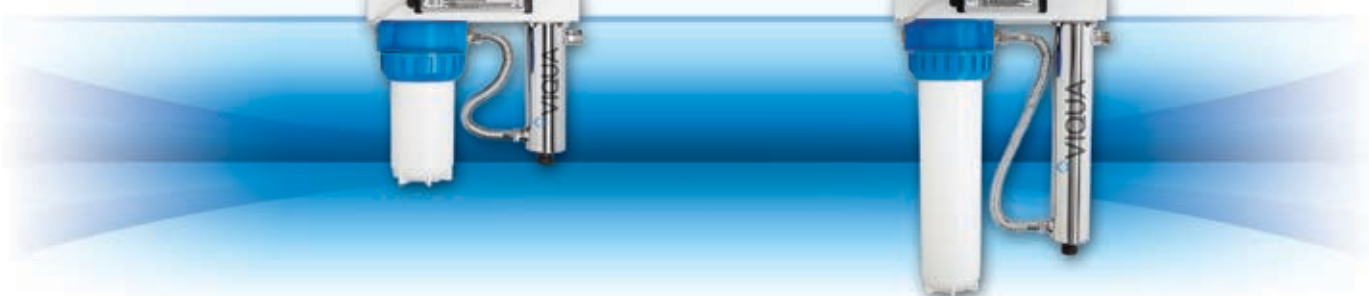



Viqua® Arros Series Systems

Part Number	Dose (30mJ/cm ²)	Length	Diameter	Inlet/Outlet	Ship Wgt	Stock	Your Price
ARROS9	9.0 GPM	11.2"	4"	¾" FPT	12 lbs.	S	Call for Pricing
ARROS15	15.0 GPM	16.5"	4"	¾" FPT	15 lbs.	S	Call for Pricing
ARROS22	22.0 GPM	22.5"	4"	¾" FPT	18 lbs.	S	Call for Pricing

Viqua Arros Series Systems include 304 Stainless Steel UV Reactor, LCD Screen Controller, and Mounting Bracket.

Viqua Arros Replacement UV Lamp/Sleeve Combo

Part Number	Description	Your Price
VA09LU	Replacement Lamp and Quartz Sleeve for Arros 9	Call for Pricing
VA15LU	Replacement Lamp and Quartz Sleeve for Arros 15	Call for Pricing
VA22LU	Replacement Lamp and Quartz Sleeve for Arros 22	Call for Pricing

VIQUA Arros Ultraviolet Water Systems

Designed for a streamlined installation, giving you time for more.

The quality of water can change over time and become contaminated with microorganisms. The VIQUA Arros™ is the premium residential UV system from VIQUA.

Reduced Installation Complexity

Innovative chamber design, mounted controller, and high output UV lamp technology form a compact unit for a clean installation.

1. The Tidal™ chamber aligns the inlet and outlet ports on a single plane, saving time and material.
2. PolyProtect™ shield blocks UV light so the Arros™ UV can plumb directly to PEX and other polymer materials.
3. System mounting is simplified with an elongated steel bracket.

Optimized Treatment Performance

Equipped with Stream™ technology which enables more accurate in-lamp usage measurement.

Minimized Maintenance Hassle

4. The all-in-one design of the VIQUA Arros lamp unit is easier to handle.
5. Threaded plug for quick, clean draining.
6. Easy-to-navigate LCD touchscreen to identify replacement parts and dealer contact information.



How Ultraviolet Works

Ultraviolet Sterilization Inactivates Bacteria, Viruses and Parasites such as Cryptosporidium & Giardia. Chlorinated tap water only keeps bacteria at low levels. The difference between Chlorination and UV is the difference between Sanitization and Sterilization. UV Sterilization provides complete protection from Microbes in water.

It is estimated that seven to 30 million Americans develop a gastrointestinal illness from drinking contaminated water. The Center for Disease Control and Prevention estimates 900 to 1,000 deaths occur from microbial illnesses from US drinking water.



Sterilight® Sterilight® Ultraviolet Systems

Sterilight® Silver™ (PA) Series UV Systems

Part Number	Dose (30mJ/cm ²)	Length	Diameter	Inlet/Outlet	Ship Wgt	Stock	Your Price
VT1	1.0 GPM	12.5"	2.6"	¾" FNPT / ½" MPT	4.0lbs.	S	Call for Pricing

Silver™ Series Systems include 304 Stainless Steel UV Reactor Standard, Audible Lamp Failure Alert, Visual "Power On", Visual Lamp Life Remaining & Total Running Time.



Sterilight® Replacement UV Lamps

Part Number	Description	Ship Wgt	Your Price
S212RL	Lamp for VT1, SQ-PA & SC1	1.0 lbs.	Call for Pricing
S287RL	Lamp for S1Q-PA, SC2.5 & SSM-14	1.0 lbs.	Call for Pricing
S330RL	Lamp for VT4, S2Q-PA, SC4 & SSM-17	1.0 lbs.	Call for Pricing
S463RL	Lamp for S5Q-PA Models & SSM-24	1.0 lbs.	Call for Pricing
S810RL	Lamp for S8Q-PA Models & SSM-37	1.5 lbs.	Call for Pricing
S36RL	Lamp for S12Q, S24Q, S40Q, SUV 24-100P & SSM-39	1.5 lbs.	Call for Pricing
S100RL-HO	Lamp for SPV-1.5 & SP100-HO	1.0 lbs.	Call for Pricing
S150RL-HO	Lamp for SPV-2.5, SP150-HO & VH150	1.0 lbs.	Call for Pricing
S200RL-HO	Lamp for VH200, SC-200, SCM-200, SPV-200, SP200-HO & SPV-3.5	1.0 lbs.	Call for Pricing
S320RL-HO	Lamp for SPV-6, SP320-HO, SC-320 & SCM-320	2.0 lbs.	Call for Pricing
S410RL-HO	Lamp for VH410, VH410M, SC-410, SCM-410, SP410-HO & SPV-8	2.0 lbs.	Call for Pricing
S600RL-HO	Lamp for VP600, VP600M, SC-600, SCM-600, SPV-600, SP600-HO & SPV-12	2.0 lbs.	Call for Pricing
S740RL-HO	Lamp for SPV-740, SPV-15, SP740-HO, SC-740 & SCM-740	2.0 lbs.	Call for Pricing
S950RL-HO	Lamp for VP950, VP950M, SPV-950, SP950-HO & SPV-20	2.0 lbs.	Call for Pricing

Sterilight® Replacement Quartz Sleeves

Part Number	Description	Ship Wgt	Your Price
QSO-150	Quartz Sleeve for VH150	1.0 lbs.	Call for Pricing
QSO-410	Quartz Sleeve for VH410	1.0 lbs.	Call for Pricing
QSO-600	Quartz Sleeve for VP600	1.0 lbs.	Call for Pricing
QSO-950	Quartz Sleeve for VP950	1.0 lbs.	Call for Pricing
QS-212	Quartz Sleeve for SQ-PA	1.0 lbs.	Call for Pricing
QS-001	Quartz Sleeve for VH200, S1Q-PA & SSM-14	1.5 lbs.	Call for Pricing
QS-330	Quartz Sleeve for S2Q-PA & SSM-17	1.5 lbs.	Call for Pricing
QS-463	Quartz Sleeve for all S5Q Models & SSM-24	1.5 lbs.	Call for Pricing
QS-810	Quartz Sleeve for all S8Q Models & SSM-37	1.5 lbs.	Call for Pricing
QS-012	Quartz Sleeve for all S12Q, S24Q, S40Q Models & SSM-39	1.5 lbs.	Call for Pricing
QS-100*	Quartz Sleeve for SP100-HO (*Limited Supply)	1.0 lbs.	Call for Pricing
QS-150	Quartz Sleeve for SP150-HO	1.0 lbs.	Call for Pricing
QS-200	Quartz Sleeve for SPV-200, SP200-HO, SC-200 & SCM-200	1.0 lbs.	Call for Pricing
QS-320	Quartz Sleeve for SP320-HO, SC-320 & SCM-320	1.0 lbs.	Call for Pricing
QS-410	Quartz Sleeve for SPV-410 & SP410-HO	1.0 lbs.	Call for Pricing
QS-600	Quartz Sleeve for SPV-600, SP600-HO, SC-600 & SCM-600	1.0 lbs.	Call for Pricing
QS-740	Quartz Sleeve for SPV-740, SP740-HO, SC-740 & SCM-740	1.0 lbs.	Call for Pricing
QS-950	Quartz Sleeve for SPV-950 & SP950-HO	1.0 lbs.	Call for Pricing

Sterilight® Miscellaneous Parts

Part Number	Description	Your Price
RN-001/1	Gland Nut/Sleeve Retaining Bolt for Sterilight and Viqua systems	Call for Pricing
602665	Quartz Sleeve Bolt for UV Max Systems	Call for Pricing

RN-001/1



602665





Sterilight® Replacement UV Lamp/Quartz Sleeve Combination

Part Number	Description	Ship Wgt	Your Price
S330-QL	Lamp & Sleeve for VT4, S2Q-PA & SSM-24		Call for Pricing
S463-QL	Lamp & Sleeve for S5Q-PA Models & SSM-24	2.5 lbs.	Call for Pricing
S810-QL	Lamp & Sleeve for S8Q-PA Models & SSM-37	3.0 lbs.	Call for Pricing
S36-QL	Lamp & Sleeve for S12Q, S24Q, S40Q, SUV 24-100P & SSM-39	3.0 lbs.	Call for Pricing
QL-200	Lamp & Sleeve for VH200 & VH200-F10	3.0 lbs.	Call for Pricing
QL-410	Lamp & Sleeve for VH410, VH410M & VH410-F20	3.0 lbs.	Call for Pricing
QL-600	Lamp & Sleeve for VP600		Call for Pricing

Sterilight® Replacement Ballasts



Part Number	Description	Ship Wgt	Your Price
BA-ICE-CL*	Ballast for Cobalt™ SC-200, SC-320, VH150, VH200 & VH410	3.0 lbs.	Call for Pricing
BA-ICE-C*	Ballasts for all Cobalt™ SC-600, SC-740, VP600 & VP950	3.0 lbs.	Call for Pricing
BA-ICE-CM*	Ballasts for all Cobalt™ "PLUS", VH410M, VP600M & VP950M Series Models	3.0 lbs.	Call for Pricing
BA-ICE-S*	Ballasts for all Silver™ Series Models	2.0 lbs.	Call for Pricing
BA-ICE-SO	Ballast / Controller Kit for 100-250V FOR S2Q-OZ, S8Q-OZ	2.0 lbs.	Call for Pricing
BA-ICE-V*	Ballasts for S2Q-PV, S5Q-PV & S8Q-PV	2.0 lbs.	Call for Pricing
BA-RO/P/12	Ballasts for S1Q-P/12VDC, S2Q-P/12VDC & S2Q-P/12VDC	4.0 lbs.	Call for Pricing
660018-R	Ballast for UV Max Model K & Sterilight Model S80	4.0 lbs.	Call for Pricing
660019-R	Ballast for UV Max Model K+ & Sterilight Model SM80	4.0 lbs.	Call for Pricing
660020-R	Ballast for Sterilight Model SV50	4.0 lbs.	Call for Pricing
602636	Detachable Power Cord for all Viqua Models	1.0 lbs.	Call for Pricing

*Power cord (Part # 602636) for these models are sold separately.

Sterilight® Ultraviolet Sensors



Part Number	Description	Case Qty	Case Wgt	Stock	Your Price
254NM-C1	UV Sensor for VH410M, VP600M, VP950M Systems	1	1.0 lbs.	S	Call for Pricing



Sterilight® Solenoid Valves

Part Number	Description	Stock	Your Price
SOL-0.5	½" Solenoid Valve, 110V./50-60Hz (260135 Power Cord Not Included)	S	Call for Pricing
SOL-0.75	¾" Solenoid Valve, 110V./50-60Hz	NS	Call for Pricing
SOL-1.0	1" Solenoid Valve, 110V./50-60Hz	S	Call for Pricing
260135	Solenoid Cable for all "PLUS" Series Systems	S	Call for Pricing
410888-R	Solenoid Kit – 2" NPT for Sterilight® S80, SM80 & SV50	NS	Call for Pricing



Superior Packaging

Our Lamps & Quartz Sleeves are shipped with superior packaging shown here. When you order with us you can be assured that your parts will arrive in perfect working order.





UV Max™ Ultraviolet Systems

UV Max™ Model E4

Part Number (Model)	Dose (30mJ/cm ²)	Length	Diameter	Inlet/Outlet	Ship Wgt	Stock	Your Price
650682 (E4)†	22 GPM	30"	4"	1" MNPT	13 lbs.	S	Call for Pricing

* Includes Timer, Alarm Reset, Lamp Life Display & Alert, Digital Display - Optional Shut-Off Valve.
 † Limited Supply

UV Max™ Models D4 & E4 PLUS Models (with UV Intensity Monitor)

Part Number (Model)	Dose (30mJ/cm ²)	Length	Diameter	Inlet/Outlet	Ship Wgt	Stock	Your Price
650695-R (Model D4 PLUS)*†	12 GPM	20.5"	4"	¾" MNPT	10 lbs.	S	Call for Pricing
650683 (Model E4 PLUS)*†	22 GPM	30"	4"	1" MNPT	14 lbs.	S	Call for Pricing

* Includes Timer, Alarm Reset, Lamp Life Display & Alert, Digital Display - Optional Shut-Off Valve.
 ** A CoolTouch Kit must be purchased also when ordering a Plus model.
 † Limited Supply

UV Max™ Models H & K (High Output Systems)

Part Number (Model)	Dose (30mJ/cm ²)	Length	Diameter	Inlet/Outlet	Ship Wgt	Stock	Your Price
650651 (Model H)*	45 GPM	31"	4"	1½" MNPT & 1" FNPT	30 lbs.	NS	Call for Pricing
660001-R (Model K)*	80 GPM	41"	4"	2" MNPT	35 lbs.	NS	Call for Pricing

* Includes CoolTouch Fan, Intuitive Interface Controller & High-Output Amalgam Lamps - 2 Year Life

UV Max™ Models H PLUS & K PLUS (High Output Systems)

Part Number (Model)	Dose (30mJ/cm ²)	Length	Diameter	Inlet/Outlet	Ship Wgt	Stock	Your Price
650652 (Model H PLUS)*	45 GPM	31"	4"	1½" MNPT & 1" FNPT	30 lbs.	NS	Call for Pricing
660002-R (Model K PLUS)*	80 GPM	41"	4"	2" MNPT	35 lbs.	NS	Call for Pricing

* Includes CoolTouch Fan, Intuitive Interface Controller & High-Output Amalgam Lamps - 2 Year Life

UV Max™ PRO Series - NSF Standard 55, Class A

Part Number (Model)	Dose (30mJ/cm ²)	Length	Diameter	Inlet/Outlet	Ship Wgt	Stock	Your Price
650647 (Model PRO 10)*	10 GPM	22"	4"	1½" MNPT & 1" FNPT	25.0 lbs.	S	Call for Pricing
650653 (Model PRO 20)*	20 GPM	31"	4"	1½" MNPT & 1" FNPT	29.6 lbs.	S	Call for Pricing
650659 (Model PRO 30)*	30 GPM	41"	4"	1½" MNPT & 1" FNPT	34.4 lbs.	S	Call for Pricing
660003-R (Model PRO 50)*†	50 GPM	41"	4"	2" MNPT	35.0 lbs.	NS	Call for Pricing

* Includes CoolTouch Fan, UV Intensity Monitor w/ Diagnostic Test & High-Output Amalgam Lamps - 2 Year Life
 † Not NSF Certified

UV Max™ CoolTouch Fan Kits

Part Number	Description	Stock	Your Price
650630	CoolTouch Fan Kit – 1" NPT (for UVMax G, H, J, K and PLUS Series & PRO Series)	S	Call for Pricing
650537	CoolTouch Valve Kit – ¾" NPT (for Viqua Systems with ¾" Port)	S	Call for Pricing
650538	CoolTouch Valve Kit – 1" NPT (for Viqua Systems with 1" Port)	S	Call for Pricing

UV Max™ Replacement UV Lamps

Part Number	Description	Ship Wgt	Your Price
602803	Replacement Lamp for UVMax System A	1.0 lbs.	Call for Pricing
602804	Replacement Lamp for UVMax System B, B4	1.0 lbs.	Call for Pricing
602805	Replacement Lamp for UVMax System C, C4, D/PLUS, D4/PLUS & Viqua	1.5 lbs.	Call for Pricing
602806	Replacement Lamp for UVMax System E/PLUS, E4/PLUS & PRO 7	1.5 lbs.	Call for Pricing
602807	Replacement Lamp for UVMax System F/PLUS, F4/PLUS & PRO 15	1.5 lbs.	Call for Pricing
602854	Replacement Lamp for UVMax System PRO 10, G/PLUS	1.0 lbs.	Call for Pricing
602855	Replacement Lamp for UVMax System PRO 20, H/PLUS	1.0 lbs.	Call for Pricing
602856	Replacement Lamp for UVMax System J/K/Plus, PRO 30, PRO 50 and Sterilight System S80, SM80 & SV50	1.0 lbs.	Call for Pricing

UV Max™ Replacement UV Lamp/Quartz Sleeve Combination

Part Number	Description	Ship Wgt	Your Price
602810-102	Lamp & Sleeve for C, C4/PLUS, D/PLUS & D4/PLUS Models	2.5 lbs.	Call for Pricing
602810-103	Lamp & Sleeve for E/PLUS, E4/PLUS & PRO 7 Models	2.5 lbs.	Call for Pricing

See Page 64 for Stainless Steel Connectors and ¾" Stainless Steel Nipples.

UV Max™ Replacement Quartz Sleeves



Part Number	Description	Ship Wgt	Your Price
602730†	Quartz Sleeve for A Model Systems († Limited Supply)	1.0 lbs.	Call for Pricing
602731	Quartz Sleeve for B & B4 Models	1.0 lbs.	Call for Pricing
602732	Quartz Sleeve for C, C4/PLUS, D/PLUS & D4/PLUS Models	1.0 lbs.	Call for Pricing
602733	Quartz Sleeve for E/PLUS & E4/PLUS Models	1.0 lbs.	Call for Pricing
602734	Quartz Sleeve for F/PLUS & F4/PLUS Models	1.0 lbs.	Call for Pricing
602974	Quartz Sleeve for G/PLUS & PRO 10 Models	1.0 lbs.	Call for Pricing
602975	Quartz Sleeve for H/PLUS & PRO 20 Models	2.0 lbs.	Call for Pricing
602976	Quartz Sleeve for J/PLUS, K/PLUS, PRO 30 & PRO 50 Models	2.0 lbs.	Call for Pricing
602665	Sleeve Bolt for All Models	1.0 lbs.	Call for Pricing

UV Max™ A, B4, C4, D4/PLUS, E4/PLUS Controllers



Part Number	Description	Ship Wgt	Your Price
650733R-002*	Replacement Power Supply Kit, 120V for C4, D4, D4-V, IHS12/22-D4	2.0 lbs.	Call for Pricing
650733R-001*	Replacement Power Supply Kit, 120V for D4+, D4-Premium, E4, E4+, IHS22-E4	2.0 lbs.	Call for Pricing
602636	Detachable Power Cord for all Viqua Models	1.0 lbs.	Call for Pricing

*The power cord (602636) for the ballast is sold separately.

UV Max™ G/H/J/PLUS Controllers



Part Number	Description	Ship Wgt	Your Price
650709-001	Replacement Power Supply Kit, for G	8.0 lbs.	Call for Pricing
650709-004	Replacement Power Supply Kit, for H	8.0 lbs.	Call for Pricing
650709-007	Replacement Power Supply Kit, for J	8.0 lbs.	Call for Pricing
650709-002	Replacement Power Supply Kit, for G PLUS	8.0 lbs.	Call for Pricing
650709-005	Replacement Power Supply Kit, for H PLUS	8.0 lbs.	Call for Pricing
650709-008	Replacement Power Supply Kit, for J PLUS	8.0 lbs.	Call for Pricing
602636	Detachable Power Cord for all Viqua Models		Call for Pricing

UV Max™ PRO Controllers

Part Number	Description	Ship Wgt	Your Price
650709-003	Replacement Power Supply Kit, for PRO 10	8.0 lbs.	Call for Pricing
650709-006	Replacement Power Supply Kit, for PRO 20	8.0 lbs.	Call for Pricing
650709-009	Replacement Power Supply Kit, for PRO 30	8.0 lbs.	Call for Pricing

UV Max™ Controllers (For Use With Systems From 1994-2008)



Part Number	Description	Ship Wgt	Your Price
650629-010	Replacement Power Supply Kit, 120V for PRO 10	8.0 lbs.	Call for Pricing
650629-020	Replacement Power Supply Kit, 120V for PRO 20	8.0 lbs.	Call for Pricing
650629-030	Replacement Power Supply Kit, 120V for PRO 30	8.0 lbs.	Call for Pricing
650629-040	Replacement Power Supply Kit, 120V for G	8.0 lbs.	Call for Pricing
650629-070	Replacement Power Supply Kit, 120V for G PLUS	8.0 lbs.	Call for Pricing
650629-050	Replacement Power Supply Kit, 120V for H	8.0 lbs.	Call for Pricing
650629-080	Replacement Power Supply Kit, 120V for H PLUS	8.0 lbs.	Call for Pricing
650629-060	Replacement Power Supply Kit, 120V for J	8.0 lbs.	Call for Pricing
650629-090	Replacement Power Supply Kit, 120V for J PLUS	8.0 lbs.	Call for Pricing
650716-006	Replacement Power Supply Kit, 120V for B& C	3.0 lbs.	Call for Pricing
650716-007	Replacement Power Supply Kit, 120V for D, D PLUS, E, E PLUS, F, F PLUS, PRO 7 & PRO 15	3.0 lbs.	Call for Pricing

UV Max™ High Flow UV Systems

Part Number (Model)	Dose (30mJ/cm²)	Length	Diameter	Inlet/Outlet	Ship Wgt	Stock	Your Price
SHF-290	290 GPM	44.5"	8"	4" MNPT	NS	286.5 lbs.	Call for Pricing
SHFM-290	290 GPM	44.5"	8"	4" MNPT	NS	287 lbs.	Call for Pricing

SHF-290

SHFM-290



Accessories for UV Systems

UV Max™ Solenoid Valves



Part Number	Description	Ship Wgt	Stock	Your Price
650627	Solenoid Kit, 24V – 1" NPT for G/PLUS, H/PLUS, J/PLUS, K/PLUS & PRO/10/20/30 Systems	2 lbs.	S	Call for Pricing
650717-001	Solenoid Kit with Junction Box, 120V – ¾" NPT for D4/PLUS Systems	3 lbs.	S	Call for Pricing
650717-002	Solenoid Kit with Junction Box, 120V – 1" NPT for E4/PLUS and F4/PLUS Series	3 lbs.	S	Call for Pricing
650705*	Solenoid/Remote Alarm w/ Junction Box, 120V – for D4/PLUS, E4/PLUS & F4/PLUS Systems	1 lbs.	S	Call for Pricing
410888-R	Solenoid Kit, 24V – 2" NPT for K/PLUS & PRO 50	10 lbs.	NS	Call for Pricing

* Input only, 24V Solenoid Valve Not Included

UV Max™ Comm Center



Part Number	Description	Ship Wgt	Stock	Your Price
270272-R	Comm Center for G/PLUS, H/PLUS, J/PLUS, K/PLUS & PRO 10/20/30 Sys. – Displays UV Dose	1 lbs.	S	Call for Pricing

UV Max™ Ultraviolet Sensors



Part Number	Description	Ship Wgt	Stock	Your Price
650580	UV Intensity Sensor for G/PLUS, H/PLUS, J/PLUS, K/PLUS & PRO Series Systems	1 lbs.	S	Call for Pricing
650703	UV Intensity Sensor for UV Max for D4 Plus/E4 Plus/F4 Plus 3½" & 4" Chambers	1 lbs.	S	Call for Pricing
650704	Item has been replaced by 650703			

Dielectric Unions*



Part Number	Description	Stock	Your Price
DF-34	¾" Dielectric Union for UV Light	S	Call for Pricing
DF-1	1" Dielectric Union for UV Light	S	Call for Pricing

*Non corrosive connection from copper to stainless steel.

Flow Restrictors



Part Number	Description	Case Wgt	Your Price
FRSS-6	6 GPM Flow Restrictor 1" x 1" FNPT	NS	Call for Pricing
FRSS-6-34	6 GPM Flow Restrictor ¾" x ¾" FNPT	NS	Call for Pricing
FRSS-8	8 GPM Flow Restrictor 1" x 1" FNPT	NS	Call for Pricing
FRSS-10	10 GPM Flow Restrictor ¾" x ¾" FNPT	NS	Call for Pricing
FRSS-12	12 GPM Flow Restrictor 1" x 1" FNPT	NS	Call for Pricing
FRSS-15	15 GPM Flow Restrictor 1" x 1" FNPT	NS	Call for Pricing
FRSS-20	20 GPM Flow Restrictor 1" x 1" FNPT	NS	Call for Pricing

All flow restrictors are made from 316L stainless steel.



Harmsco® WaterBetter® Filter Housings

Part Number	Filter Height	Drain	Diameter	Outlet	Inlet	Pipe Size (NPT)	Drain Size (NPT)	Floor Space	Service Height	Ship Wgt	Your Price
WB-40SC-1*	19¼"	4½"	13"	3¾"	4¼"	1"	1"	15"x15"	31"	40	Call for Pricing
WB-40SC-2	19¼"	4½"	13"	3¾"	4¼"	2"	1"	15"x15"	31"	40	Call for Pricing
WB-90SC-1*	29¾"	4½"	13"	3¾"	4¼"	1"	1"	15"x15"	51"	51	Call for Pricing
WB-90SC-2	29¾"	4½"	13"	3¾"	4¼"	2"	1"	15"x15"	51"	51	Call for Pricing
WB-170SC-1*	39¾"	4½"	13"	3¾"	4¼"	1"	1"	15"x15"	72"	64	Call for Pricing
WB-170SC-2	39¾"	4½"	13"	3¾"	4¼"	2"	1"	15"x15"	72"	64	Call for Pricing

* For 1" plumbing; not NSF Listed.

Harmsco® WB WaterBetter® single-cartridge filters deliver high flow, extended filter life, increased dirt holding capacity and ease of operation. Certified to ANSI-NSF 61*

Applications

- ◆ Commercial/Residential Drinking Water
- ◆ Cooling Tower Filtration
- ◆ Desalination Pre-filtration (coated option)
- ◆ P.O.E. for household
- ◆ Industrial Waste Water Treatment
- ◆ Reverse Osmosis Pre-filtration
- ◆ Groundwater Remediation
- ◆ Utility Water

Features

- ◆ Patented Up-flow design
- ◆ Electropolished 304 stainless steel housing
- ◆ Fail Safe closure system
- ◆ Three sizes for greater media surface area
- ◆ CPVC standpipe (standard) - stainless steel optional
- ◆ Simple alternative to complex multiple cartridge housings
- ◆ Largest selection available of cartridge micron ratings and media, including carbon block
- ◆ Reduced installation cost

WB-40SC

WB-90SC

WB-170SC

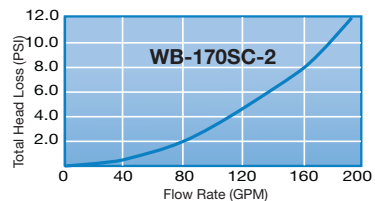
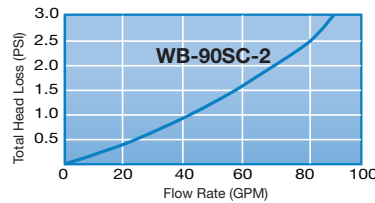
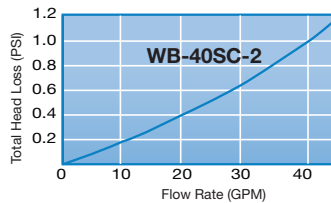

The total head loss data shown above was developed by NSF International and indicates pressure drop with WaterBetter® filter housings and 20 micron filter cartridges in clean water.

Features

- ◆ Electropolished 304 stainless steel
- ◆ **Standpipe** - CPVC
- ◆ **Temperature** - 140°F (60°C) max. Up to 200°F (93°C) with optional stainless steel standpipe and high temperature cartridges installed
- ◆ **Pressure** - 150 psi (10 bar) max.
- ◆ **Wing nuts** - Brass
- ◆ **Rim gaskets** - EPDM (Buna-N, Viton available)
- ◆ BSTP optional





Harmsco® Hurricane® Filter Housings

Part Number	Filter Height	Width	Diameter	Outlet	Inlet	Pipe Size (NPT)	Drain Size (NPT)	Floor Space	Service Height	Ship Wgt	Stock	Your Price
HUR-40-HP	19¼"	14¾"	13"	37/16"	12¾"	2"	1"	15"x15"	31"	40 lbs.	NS	Call for Pricing
HUR-90-HP	29¾"	14¾"	13"	37/16"	17¾"	2"	1"	15"x15"	51"	52 lbs.	S	Call for Pricing
HUR-170-HP	39¾"	14¾"	13"	37/16"	23¾"	2"	1"	15"x15"	72"	64 lbs.	S	Call for Pricing

Harmsco® HP Hurricane® filters provide unsurpassed performance. Our unique design separates dense solids prior to cartridge filtration for extended filter life, increased dirt holding capacity and reduced maintenance costs. Certified to ANSI-NSF 61.

Applications

- ◆ Commercial/Residential Drinking Water
- ◆ Cooling Tower Filtration
- ◆ Desalination Pre-filtration (coated option)
- ◆ Surface Water Treatment Rule (SWTR) LT2
- ◆ Process Water
- ◆ Whole House Filtration
- ◆ Industrial Waste Water Treatment
- ◆ Reverse Osmosis Pre-filtration
- ◆ Small Community Compliance LT2
- ◆ Well Water
- ◆ Groundwater Remediation
- ◆ Groundwater Under Direct Influence (GUDI)

Features

- ◆ Combination cyclone separator and cartridge filter in a single compact design
- ◆ Patented Up-flow design with tangential entry – prevents air entrapment
- ◆ Rotational flow “flutters” media pleats – improving loading performance
- ◆ Electropolished 304 or 316L stainless steel housing
- ◆ Fail-Safe lid closure, rated for 150 psi
- ◆ Three sizes for greater media surface area
- ◆ CPVC standpipe (standard) – stainless steel optional
- ◆ Largest selection available of cartridge micron ratings and media, including carbon block
- ◆ NSF/ANSI Standard 61 Listed

HUR-40-HP

HUR-90-HP

HUR-170-HP



Harmsco Hurricane Technology

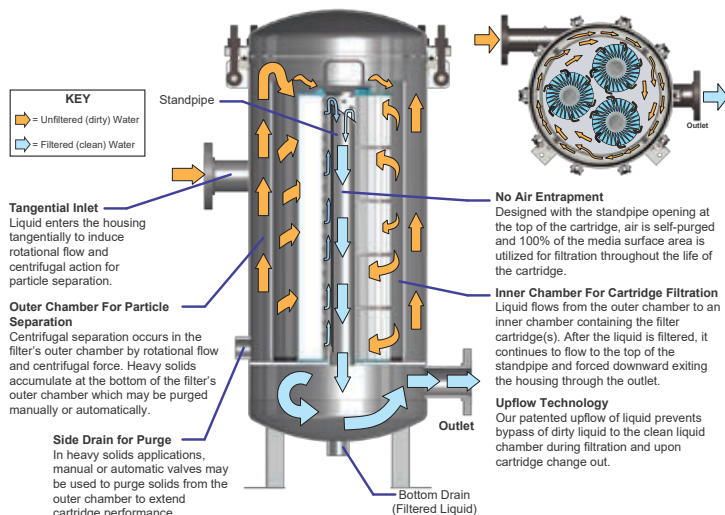

Features

- ◆ Electropolished 304 or 316L stainless steel
- ◆ **Temperature** - 140°F (60°C) max. Up to 250°F (121°C) with optional stainless steel standpipe and high temperature cartridges installed
- ◆ **Pressure** - 150 psi (10 bar) max.
- ◆ **Wing nuts** - brass
- ◆ **Rim gaskets** - EPDM (Buna-N, Viton available)
- ◆ **BSTP** optional



Harmsco® Up-Flow Filter Housings

Part Number	Height	Diameter	Leg Width	Drain Height	Service Height	Inlet/Outlet	Drain Size (NPT)	Stock	Your Price
HIF-7	19½"	13"	13"	3½"	35"	1½" NPT	1"	S	Call for Pricing
HIF-14	28"	13"	13"	3½"	48"	1½" NPT	1"	S	Call for Pricing
HIF-16	28"	13"	13"	4"	48"	2" NPT	1"	S	Call for Pricing
HIF-21	37"	13"	13"	3½"	68"	1½" NPT	1"	S	Call for Pricing
HIF-24	37"	13"	13"	4"	68"	2" NPT	1"	S	Call for Pricing
HIF-42	40"	18"	18"	5¾"	68"	2" NPT	1"	S	Call for Pricing
HIF-75	42"	20"	20"	6¾"	70"	3" NPT	1½"	S	Call for Pricing

This product is designed with a patented Up-flow technology which prevents the accumulation of air inside the filter housing keeping the filter operating at 100%. Certified to ANSI-NSF 61*

Applications

- ◆ Commercial/Residential Drinking Water
- ◆ Cooling Tower Filtration
- ◆ Process Water
- ◆ Reverse Osmosis Pre-filtration
- ◆ Groundwater Remediation
- ◆ Utility Water
- ◆ Industrial Waste Water Treatment
- ◆ Surface Water Treatment Rule (SWTR) LT2

Features

- ◆ NSF/ANSI Standard 61 listed
- ◆ Patented Up-flow design
- ◆ 304 stainless steel construction, standard
- ◆ Electropolished finish, standard
- ◆ 150 psi (10.3 bar) pressure rating
- ◆ Flow Rates up to 800 GPM
- ◆ All filter housings hydrostatically tested
- ◆ Easy cartridge installation, removal and service
- ◆ Individual studs for safe, secure lid closure
- ◆ Extensive choice of cartridge micron ratings and media

HIF SERIES



Filter Specifications

- ◆ **Filter Vessel / Metal Components** - 304 stainless steel, electropolished for increased resistance to corrosion
- ◆ **Holding / Lifting Rods, Standpipes and Pipe Caps** - CPVC, standard models; 304 stainless steel for All Stainless models
- ◆ **Rim Gaskets** - EPDM, standard; Buna-N, Viton available
- ◆ **O-rings** - Buna-N, standard; EPDM, Viton available
- ◆ **Bottom Seals** - natural gum rubber, standard; EPDM, Viton available
- ◆ **Pressure** - rated for pressures to 150 psi (10.3 bar) max
- ◆ **Temperature** - rated to 140°F (60°C) with CPVC rods, pipe caps, standpipes and standard Harmsco cartridges; to 200°F (93°C) for all stainless models with stainless steel rods, pipe caps and standpipes, and Harmsco High-Temp cartridges
- ◆ **Flow** - up to 800 GPM; typical flow rates are 4-6 GPM per single length (9-3/4")
- ◆ **Wing Nuts** - brass; optional brass hex nuts and stainless steel flat washers





HarmSCO® Band Clamp 4 Cartridge Filter Housings

Part Number	Material	No. of Cartridges	Filter Height	Service Height	Height	Width	Diameter	Inlet/Outlet	Flow Rate	Max. Flow Rate	Stock	Your Price
BC4-1-T-EP	304L	4	9¾" or 10"	28"	19½"	11½"	9½"	2"	12	25	NS	Call for Pricing
BC4-1-T-EP-316	316L	4	9¾" or 10"	28"	19½"	11½"	9½"	2"	12	25	NS	Call for Pricing
BC4-2-T-EP	304L	4	19½" or 20"	47"	29¼"	11½"	9½"	2"	24	50	NS	Call for Pricing
BC4-2-T-EP-316	316L	4	19½" or 20"	47"	29¼"	11½"	9½"	2"	24	50	NS	Call for Pricing
BC4-3-T-EP	304L	4	29¼" or 30"	67"	39"	11½"	9½"	2"	36	75	S	Call for Pricing
BC4-3-T-EP-316	316L	4	29¼" or 30"	67"	39"	11½"	9½"	2"	36	75	NS	Call for Pricing

HarmSCO® Band Clamp 6 Cartridge Filter Housings

Part Number	Material	No. of Cartridges	Filter Height	Service Height	Height	Width	Diameter	Inlet/Outlet	Flow Rate	Max. Flow Rate	Stock	Your Price
BC6-1-T-EP	304L	6	9¾" or 10"	35"	25½"	12"	9½"	2"	18	42	NS	Call for Pricing
BC6-1-T-EP-316	316L	6	9¾" or 10"	35"	25½"	12"	9½"	2"	18	42	NS	Call for Pricing
BC6-2-T-EP	304L	6	19½" or 20"	54"	35¼"	12"	9½"	2"	36	84	NS	Call for Pricing
BC6-2-T-EP-316	316L	6	19½" or 20"	54"	35¼"	12"	9½"	2"	36	84	NS	Call for Pricing
BC6-3-T-EP	304L	6	29¼" or 30"	74"	45"	12"	9½"	2"	54	126	NS	Call for Pricing
BC6-3-T-EP-316	316L	6	29¼" or 30"	74"	45"	12"	9½"	2"	54	126	NS	Call for Pricing

HarmSCO® Band Clamp housings are designed with a patented Up-flow technology which prevents the accumulation of air inside the filter housing keeping the filter operating at 100%.

Applications

- ◆ Commercial/Residential Drinking Water
- ◆ Cooling Tower Filtration
- ◆ Process Water
- ◆ Reverse Osmosis Pre-filtration
- ◆ Groundwater Remediation
- ◆ Utility Water
- ◆ Industrial Waste Water Treatment
- ◆ Groundwater Under Direct Influence (GUDI)

Features

- ◆ 304 stainless steel construction, standard
- ◆ Electropolished finish, standard
- ◆ 150 psi (10.3 bar) pressure rating
- ◆ Flow rates up to 126 GPM
- ◆ All filter housings hydrostatically tested
- ◆ Stainless steel cartridge lifters for easy cartridge removal
- ◆ Adjustable top plates to accept various length cartridges
- ◆ Two drains provided - inlet and outlet fluids
- ◆ Extensive choice of cartridge micron ratings and media
- ◆ Integral mounting legs, drill in place

Specifications

- ◆ **Finish** - Electropolish standard; poly coat optional
- ◆ **Inlet / Outlet** - 2" FNPT; sanitary, BSTP, victaulic connections optional
- ◆ **Closure** - Band clamp closure, O-rings Buna-N
- ◆ **Pressure** - Up to 150 psi (10.3 bar) max
- ◆ **Temperature** - up to 250°F(121°C), housing only
- ◆ **Construction** - 304 stainless steel standard; 316 optional





Harmsco® FSSS 9¾" Single Cartridge Housings

Part Number	Material	Length	Inlet/Outlet	End Configuration	Filter Height	Inlet/Outlet Width	Diameter	Inlet	Stock	Your Price
FSSS-1A	316 SS	9¾"	¾"	DOE	13"	3.2"	4.06"	11.84	NS	Call for Pricing
FSSS-1B	304 SS	9¾"	¾"	DOE	13"	3.2"	4.06"	11.84	NS	Call for Pricing
FSSS-1A-222	316 SS	9¾"	¾"	222/Flat	13"	3.2"	4.06"	11.84	NS	Call for Pricing

Harmsco® FSSS 20" Single Cartridge Housings

Part Number	Material	Length	Inlet/Outlet	End Configuration	Filter Height	Inlet/Outlet Width	Diameter	Inlet	Stock	Your Price
FSSS-2A	316 SS	20"	1"	DOE	23"	3.2"	4.06"	21.84	NS	Call for Pricing
FSSS-2B	304 SS	20"	1"	DOE	23"	3.2"	4.06"	21.84	NS	Call for Pricing
FSSS-2A-222	316 SS	20"	1"	222/Flat	23"	3.2"	4.06"	21.84	NS	Call for Pricing

FSSS Series Filter Housings are designed with a double o-ring compression which allows for positive sealing and easy access. Offered in DOE (double open end) or 222/Flat configurations.

Applications

- ◆ Food & Beverage Filtration
- ◆ Reverse Osmosis Filtration
- ◆ Process Water Filtration
- ◆ Cutting Fluids
- ◆ Lubricants
- ◆ Plating Solutions
- ◆ High Purity Water
- ◆ Inks



Knife-edge seal to prevent by-pass

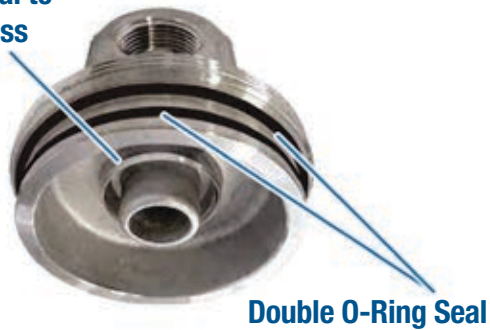

Features

- ◆ 304 or 316 stainless steel construction
- ◆ 300 PSI (20.7 bar) pressure rating
- ◆ Electro-polished finish
- ◆ Offered in Double Open End or 222 / Flat configurations
- ◆ Double o-ring compression seal for easy change out
- ◆ Includes 1/8" NPT vent and 1/8" NPT drain
- ◆ Inline design for easy installation
- ◆ Knife edge seal at both cartridge ends to eliminate by-pass for DOE cartridges
- ◆ Standard with wrench and mounting bracket

Specifications

- ◆ **Finish** - electro-polished
- ◆ **Inlet/Outlet** - 3/4" on 9-3/4" housings and 1" on 20" housings
- ◆ **Construction** - 304 or 316 stainless steel
- ◆ **Pressure** - up to 300 psi (20.7 bar) max
- ◆ **Temperature** - up to 250°F (121°C) (filter housing only)
- ◆ **O-ring Closure Seal** - silicone (standard)

Pressure Drop

Based on 3/4" and 1" inlet/outlet housings, without cartridges.

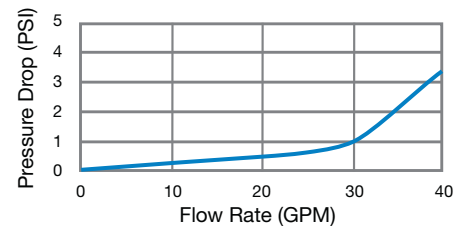



Shelco® Gasket Seals

Part Number	Description	Stock	Your Price
8017-B	Gasket for 4FOS, 5FOS, BFC & BFS Series, Buna (Clamp Style)	S	Call for Pricing
10017-B	Gasket for 7FOS & SJCH Series, Buna (Clamp Style)	S	Call for Pricing
20041-B	Gasket for FOS Series, Shell Buna	S	Call for Pricing
20041-EPR	Gasket for FOS Series, Shell Ethylene Propylene	S	Call for Pricing
20041-T	Gasket for FOS Series, Shell Teflon	S	Call for Pricing
20041-V	Gasket for FOS Series, Shell Viton	S	Call for Pricing
2072-B	Gasket for FOS Series, Cap Nut Buna	S	Call for Pricing
2072-EPR	Gasket for FOS Series, Cap Nut Ethylene Propylene	S	Call for Pricing
2072-T	Gasket for FOS Series, Cap Nut Teflon	NS	Call for Pricing
2072-V	Gasket for FOS Series, Cap Nut Viton	S	Call for Pricing
10017-EPR	Gasket for 7FOS & SJCH Series, EPR (Clamp Style)	NS	Call for Pricing
10017-S	Gasket for 7FOS & SJCH Series, Silicone (Clamp Style)	NS	Call for Pricing
10017-SB-S	Gasket for 7FOS & SJCH Series, Silicone (Swing Bolt Style)	NS	Call for Pricing
12021-B	Gasket for 12FOS, 12SD, & 12UD Series, Buna (Clamp Only)	NS	Call for Pricing
12021-B-R	Gasket for 12FOS, 12SD, & 12UD Series, Buna (Clamp Only)	NS	Call for Pricing
12021-EPR	Gasket for 12FOS, 12SD, & 12UD Series, EPR (Clamp Style)	NS	Call for Pricing
12021-SB-B	Gasket for 12FOS, 12SD, & 12UD Series, Buna (Swing Bolt Style)	NS	Call for Pricing
12021-SB-EPR	Gasket for 12FOS, 12SD, & 12UD Series, EPR (Swing Bolt Style)	NS	Call for Pricing
12021-SB-S	Gasket for 12FOS, 12SD, & 12UD Series, Silicone (Swing Bolt Style)	NS	Call for Pricing
12021-S-R	Gasket for 12FOS, 12SD, & 12UD Series, Silicone (Swing Bolt Style)	NS	Call for Pricing
16021-EPR	Gasket for 22FOS & 2BFS Series, EPR (Clamp Style)	NS	Call for Pricing
20021-SB-EPR	Gasket for 32FOS, 3BFS, & 4BFS Series, EPR (Swing Bolt Style)	NS	Call for Pricing
24021-SB-B	Gasket for 52FOS, 5BFS, & 6BFS Series, Buna (Swing Bolt Style)	NS	Call for Pricing
8017-S	Gasket for 4FOS, 5FOS, BFC, & BFS Series, Silicone (Clamp Style)	S	Call for Pricing
8017-SB-B	Gasket for 4FOS, 5FOS, BFC, & BFS Series, Buna (Swing Bolt Style)	NS	Call for Pricing
8017-SB-S	Gasket for 4FOS, 5FOS, BFC, & BFS Series, Silicone (Swing Bolt Style)	NS	Call for Pricing
8017-SB-V	Gasket for 4FOS, 5FOS, BFC, & BFS Series, Viton (Swing Bolt Style)	NS	Call for Pricing
8017-V	Gasket for 4FOS, 5FOS, BFC, & BFS Series, Viton (Clamp Style)	NS	Call for Pricing
8725-B	Gasket for BF Series, Buna (Basket)	NS	Call for Pricing

20021-SB-EPR

10017-SB-S

8017-V

8017-SB-S

8017-B



Big-Bubba® Housing

Part Number	Description	Port Size	Flow Rate	Ship Wgt	Your Price
BBH-150	Big-Bubba® Industrial Polypropylene Filter Housing	2" Slip	150 GPM	47 lbs.	Call for Pricing

Big-Bubba® Cartridges



Part Number	Description	Your Price
BBC-150-P5	5µ Pleated Cartridge	Call for Pricing
BBC-150-P20	20µ Pleated Cartridge	Call for Pricing
BBC-150-P50	50µ Pleated Cartridge	Call for Pricing
BBC-150-PM150	150µ Pleated Cartridge	Call for Pricing
BBC-150-D1	1µ Melt Blown Polypropylene Cartridge	Call for Pricing
BBC-150-D5	5µ Melt Blown Polypropylene Cartridge	Call for Pricing
BBC-150-D20	20µ Melt Blown Polypropylene Cartridge	Call for Pricing
BBC-150-D50	50µ Melt Blown Polypropylene Cartridge	Call for Pricing
BBC-150-ACP	Big-Bubba® Activated Carbon	Call for Pricing



BIG-BUBBA® FILTERS

Rugged Construction

Big-Bubba filter housings are made of rugged, glass-reinforced polypropylene so they will not chip, rust, or dent. And because all wetted surfaces are non-metallic, they are ideal when chemical compatibility is an issue and for sea water applications.

Applications

Big-Bubba filters are ideal for a wide range of applications, including:

- ◆ Commercial filtration
- ◆ Industrial filtration
- ◆ Pre-filtration for RO equipment
- ◆ Community water systems
- ◆ Sea water applications due to their non-corrosive construction
- ◆ Replacement for bag filters for more filter area
- ◆ Replacement for multiple cartridge filters for greater convenience
- ◆ Water for livestock & poultry
- ◆ Whole house filtration

Low Pressure Drop

Big-Bubba filter housings are designed to minimize pressure drop, by using 2" pipe fittings and a large diameter center tubes for Big-Bubba filter cartridges. (See chart below for pressure drop data using pleated cartridges.)

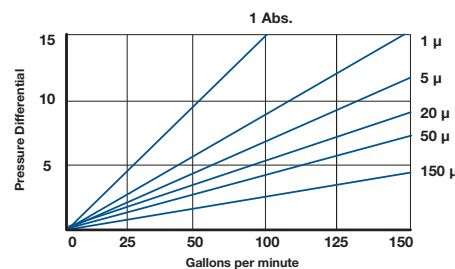

E-Z Change-Out

Cartridge replacement is easy as 1-2-3:

- ◆ Remove swing bolts
- ◆ Remove lid
- ◆ Rotate cartridge ¼" turn and pull-up

Proprietary Cartridges

We offer a full line of replacement cartridges for Big-Bubba filters, all with double o-ring seals for superior performance. Cartridges are easy to install, easy to service and easy to replace. Some of the filter media we use in select micron ratings are cleanable and reusable to reduce filtration costs.



TERMS AND CONDITIONS

Payment Terms

We accept Visa, MasterCard, Amex, or other advance payment via wire transfer, check or other certified funds. Payment terms are available with an approved credit application. H2O Filter Warehouse requires all initial orders to be prepaid.

Minimum Orders

Minimum Order is \$30 per shipment (Samples Excluded). Orders less than \$30 will be accepted with a \$7.50 Order Processing Fee. This fee allows us to earn a few dollars, instead of losing a few, when processing small orders.

COD Terms

H2O Filter Warehouse does not ship COD.

Shipping

All shipments are F.O.B. our warehouse in Marietta, GA. All freight billing is Prepay and Add. We do not use customer shipper numbers for freight billing (i.e. Collect; Third Party billing). Freight quotes are estimates based on the best information available at the time of the request. H2O Filter Warehouse reserves the right to bill for additional freight charges or incidental freight costs that are charged to us, on your behalf by the carrier.

Transportation

Claims for damaged goods in shipment or shortages must be made by the customer directly with the freight company. Once a pallet has been signed for, the trucking company removes itself from any responsibility for missing boxes, and/or damage. H2O cannot be responsible for damages or lost packages caused by freight carriers.

International Orders

International Orders must be prepaid in full in U.S. funds via wire transfer. Many product warranties do not provide coverage outside the U.S. H2O makes no guarantee of warranty coverage, serviceability, or compatibility for products that are used outside of the U.S. All duties, customs, taxes, tariffs, import fees, broker charges, etc. are the responsibility of the purchaser.

Returns

All returns must be approved by H2O Filter Warehouse and a return authorization (RA) form with a number must be issued. Sales returns are allowed for a maximum

Returns (cont.)

of 30 days from the original invoice date. A restocking charge of 15% will apply to returned goods. Products must be received in commercially resalable condition to be eligible for refund. Products returned wet or having been wet or not in their original factory packaging or shrink wrapping are not eligible for refund. Merchandise must be returned to H2O Filter Warehouse freight prepaid. Any restocking fee that is charged to us by our supplier, on your behalf, will be passed on. (See Returns Goods Policy) Shipping services are not refundable. Special Order or Custom-Built Equipment is not eligible to be returned. Special Order Goods are not returnable.

Verbal Orders

We prefer all our orders to be placed in writing via fax or email. Verbal orders and changes to orders will be accepted only with the understanding that H2O Filter Warehouse is not responsible for freight charges for returned merchandise ordered verbally. We will fax or email an order confirmation for your review to help ensure accuracy.

Limited Warranty

Many H2O Filter Warehouse products have a limited warranty covering workmanship and materials. Some products sold by H2O Filter Warehouse have no warranty, or they are covered by the original manufacturer's warranty. Please contact H2O Filter Warehouse for more information regarding warranties.

Product Suitability

Suitability of any product for any application is the responsibility of the buyer. H2O makes no warranty, expressed or implied, concerning any product and its suitability.

Prices

Prices are subject to change without notice. Our web site has our latest PDF version of this document, with our latest prices, available to download anytime.

Past Due Accounts

H2O Filter Warehouse does not ship orders to customers whose account is past due. A 1.5% per month service charge will be applied to all past due accounts.





H2O Filter Warehouse

1060 Triad Court, Suite A
Marietta, GA 30062-2262
TEL: 770-874-2608 / 800-955-0556
FAX: 770-424-2464



Password protected, downloadable PDF, updated regularly
Convenient online ordering with our e-order form